

# LED T8 REPLACEMENT LAMP INSTALLATION INSTRUCTIONS

## Items:

L2T8B/835/9F/DE-39  
L2T8B/850/9F/DE-39

L4T8B/835/14F/DE-39  
L4T8B/850/14F/DE-39

L2T8B/840/9F/DE-39  
L2T8B/885/9F/DE-39

L4T8B/840/14F/DE-39  
L4T8B/865/14F/DE-39

## Operation Instruction

— Double & Single ended By Pass/Line Voltage

Product Name: LED T8 Tube Series

Product Model: T8-LED

### 1. Product Features:

- UL certified
- Full glass housing: No Aging, Yellowing, Bending.
- Single ended: 
- Double ended: 

### 2. Product Applications:

Widely used in residential buildings, offices, shopping malls, supermarkets, hospitals, assembly lines, warehouses, etc. for energy saving illumination.

### 3. Installation Instructions:

Please completely comply with these instructions and notes, to ensure that the product is operated in a safe condition.

#### ⚠ Safety Precautions:

For your and others' safety, please read the precaution carefully before installation:

- (1). Product should be installed by qualified electrician.
- (2). Switch off the power supply before commencing work, make sure correct connection before power on.
- (3). NOT FOR EMERGENCY LIGHTING.

#### ⚠ WARNING:

**WARNING - Risk of fire or electric shock. LED Retrofit Kit installation requires knowledge of luminaire electrical systems. If not qualified, do not attempt installation. Contact a qualified electrician.**

**AVERTISSEMENT - Risque d'incendie ou de choc électrique. Installation du kit de Retrofit LED exige une connaissance des systèmes électriques luminaires. Si vous n'êtes pas qualifié, ne tentez pas de l'installation. Contactez un électricien qualifié.**

**WARNING - Risk of fire or electric shock. Install this kit only in the luminaires that have the construction features and dimensions shown in the photographs and/or drawings and where the input rating of the retrofit kit does not exceed the input rating of the luminaire.**

**AVERTISSEMENT - Risque d'incendie ou de choc électrique. Installez ce kit dans les luminaires qui ont les caractéristiques de construction et les dimensions indiquées dans les photographies et / ou dessins et où la cote d'entrée du kit de modification ne dépasse pas la capacité d'entrée du luminaire.**

**WARNING -To prevent wiring damage or abrasion, do not expose wiring to edges of sheet metal or other sharp objects.**

**AVERTISSEMENT - Pour éviter d'endommager le câblage ou à l'abrasion, ne pas exposer le câblage aux bords de tôle ou d'autres objets pointus.**

**Do not make or alter any open holes in an enclosure of wiring or electrical components during kit installation.**

**Installers should not disconnect existing wires from lamp holder terminals to make new connections at lamp holder terminals. Instead installers should cut existing lamp holder leads away from the lamp holder and make new electrical connections to lamp holder lead wires by employing applicable connectors.**

**THE RETROFIT ASSEMBLY IS ACCEPTED AS A COMPONENT OF A LUMINAIRE WHERE THE SUITABILITY OF THE COMBINATION SHALL BE DETERMINED BY UL OR AUTHORITIES HAVING JURISDICTION.**

**THERE ARE TUBE, OPERATION INSTRUCTION AND FILED THE DOUBLE-ENDED OR SINGLE-ENDED APPLICATION LABEL IN THIS RETROFIT KIT.**

This device complies with Part 15 of the FCC Rules. Operation is subject to the following two conditions:  
(1) this device may not cause harmful interference, and (2) this device must accept any interference received, including interference that may cause undesired operation.

The units covered by this report were intended to retrofit surface mount with diffuser for these models. Type IC or non-IC recessed mount listed fluorescent luminaires that use maximum four tubular lamps, the minimum lamp compartment dimensions are tabulated below:

Model Number	MINIMUM LAMP COMPARTMENT DIMENSIONS [Length x Width x Height] [mm]	Lamp Quantity
L2T8B/8XX/9F/DE-39	654.4 x 76.2 x 50.7	4
L4T8B/8XX/14F/DE-39	1262.8 x 76.2 x 50.7	4

Topaz Lighting Corp.  
925 Waverly Ave, Holtsville, NY 11742.  
Tel: 1-800-666-2852  
Fax: 1-631-758-8026

# LED T8 REPLACEMENT LAMP INSTALLATION INSTRUCTIONS

## Items:

L2T8B/835/9F/DE-39  
L2T8B/850/9F/DE-39

L4T8B/835/14F/DE-39  
L4T8B/850/14F/DE-39

L2T8B/840/9F/DE-39  
L2T8B/885/9F/DE-39

L4T8B/840/14F/DE-39  
L4T8B/865/14F/DE-39

⚠ The below ballast wiring represents typical configuration. The actual ballast wiring varies according to ballast model. The socket should be non-shunted.

### Single ended Wiring Instruction

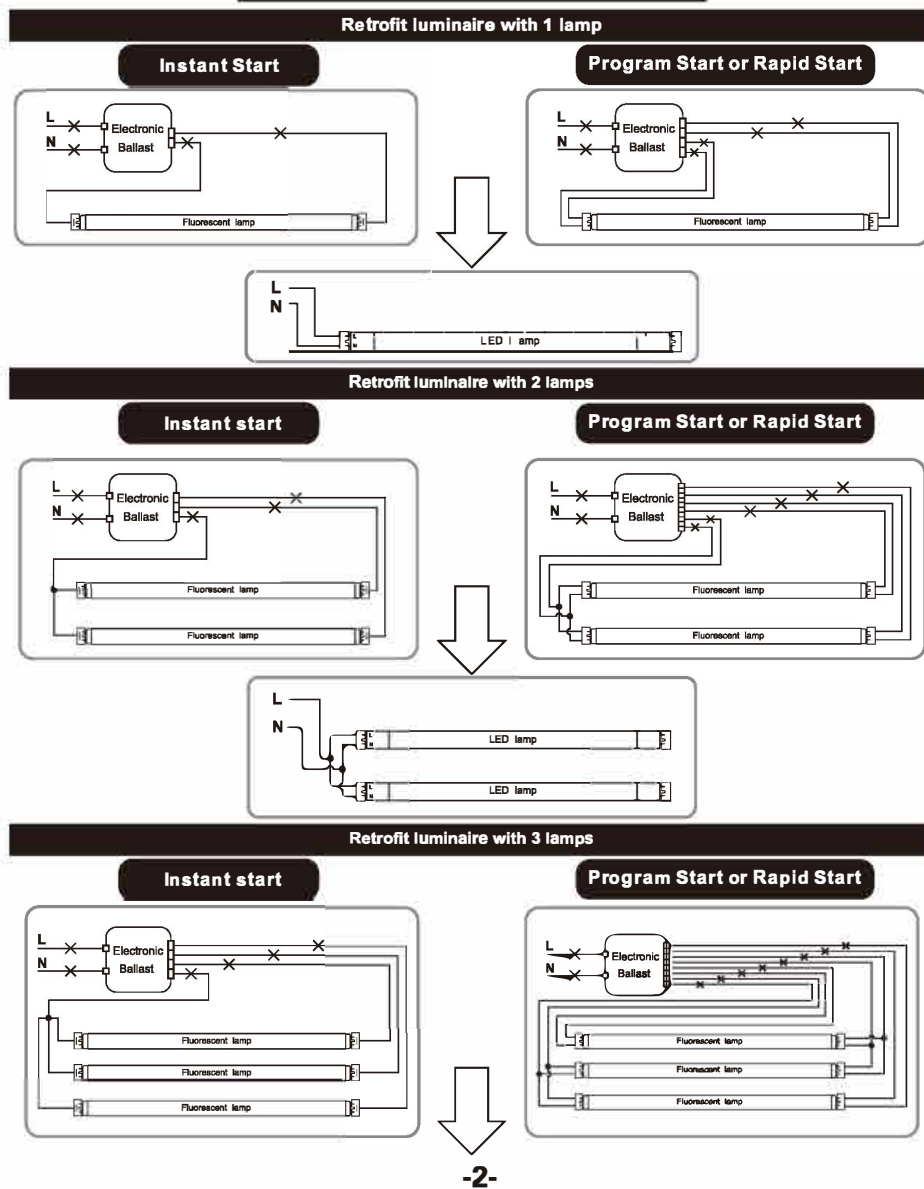

# LED T8 REPLACEMENT LAMP INSTALLATION INSTRUCTIONS

## Items:

L2T8B/835/9F/DE-39  
L2T8B/850/9F/DE-39

L4T8B/835/14F/DE-39  
L4T8B/850/14F/DE-39

L2T8B/840/9F/DE-39  
L2T8B/885/9F/DE-39

L4T8B/840/14F/DE-39  
L4T8B/865/14F/DE-39

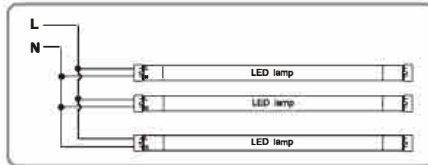

### Retrofit luminaire with 4 lamps

#### Instant start

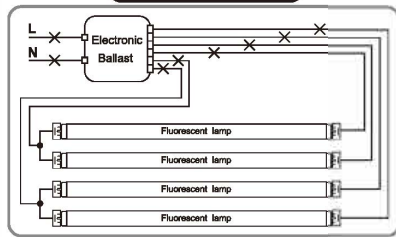

#### Program Start or Rapid Start

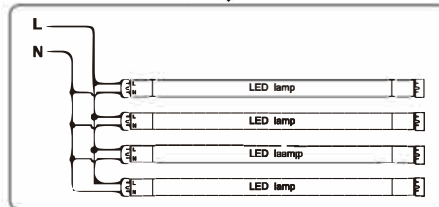
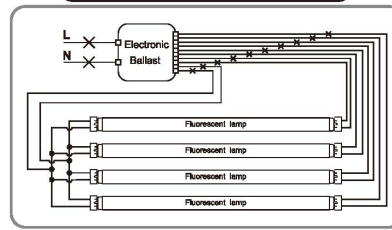

⚠ The below ballast wiring represents typical configuration. The actual ballast wiring varies according to ballast model. It is not needed to change socket (if in good condition) to operate double ended lamps, regardless the type of sockets. Please make sure one side of fixture is connected to Live (L) and the other side to Neutral (N).

### Double ended Wiring Instruction

#### Retrofit luminaire with 1 lamp

#### Instant Start

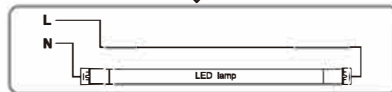
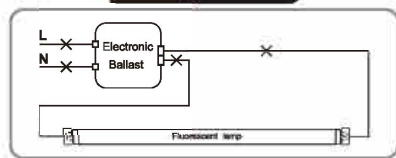

#### Program Start or Rapid Start

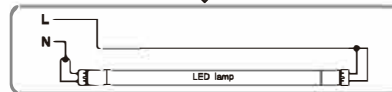
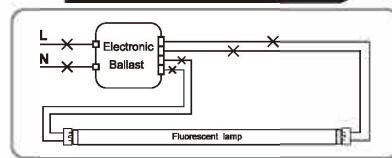

# LED T8 REPLACEMENT LAMP INSTALLATION INSTRUCTIONS

**Items:**

L2T8B/835/9F/DE-39  
L2T8B/850/9F/DE-39

L4T8B/835/14F/DE-39  
L4T8B/850/14F/DE-39

L2T8B/840/9F/DE-39  
L2T8B/885/9F/DE-39

L4T8B/840/14F/DE-39  
L4T8B/865/14F/DE-39

**Retrofit luminaire with 2 lamps**

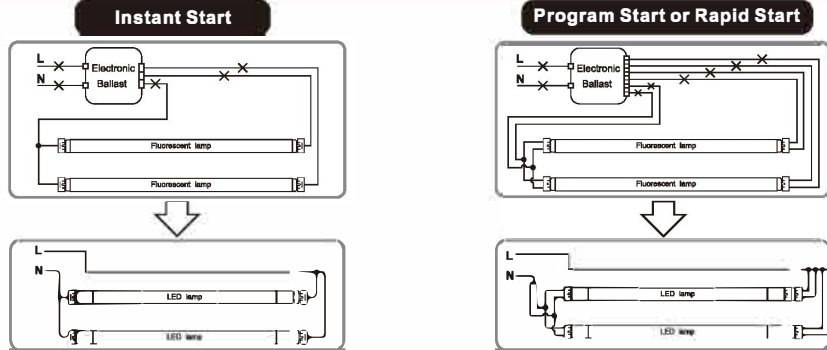

**Retrofit luminaire with 3 lamps**

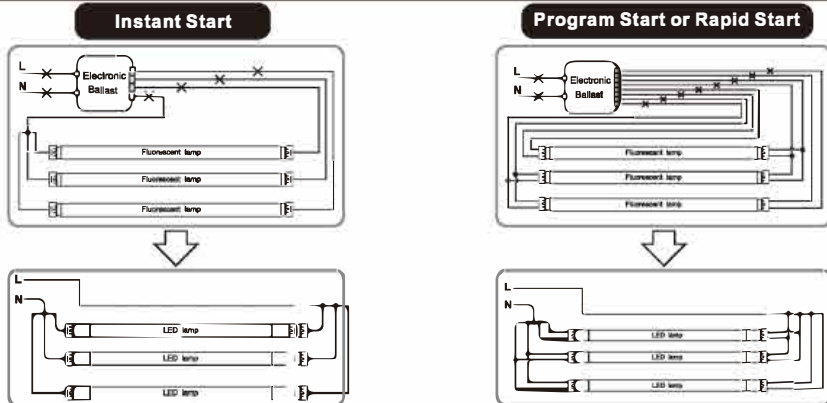

**Retrofit luminaire with 4 lamps**

