

SIDES	BOTTOM
1 PCS #10-32×1/2 Screws Installed	
Material:Steel-0.0625"-C. R. S Galvanized	

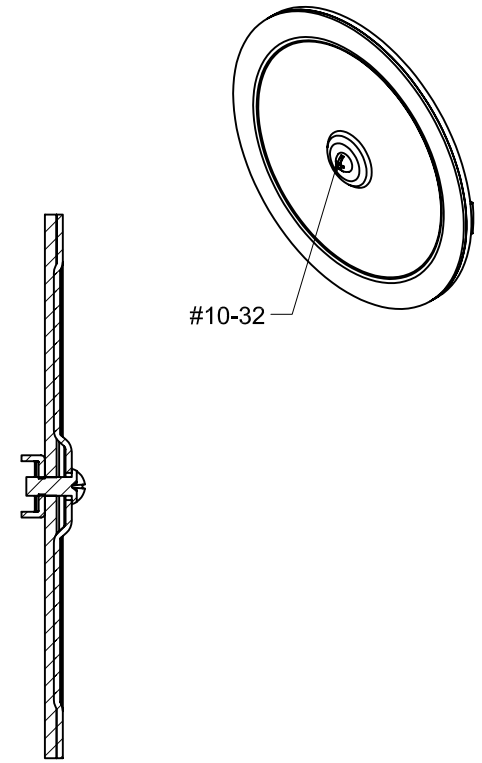
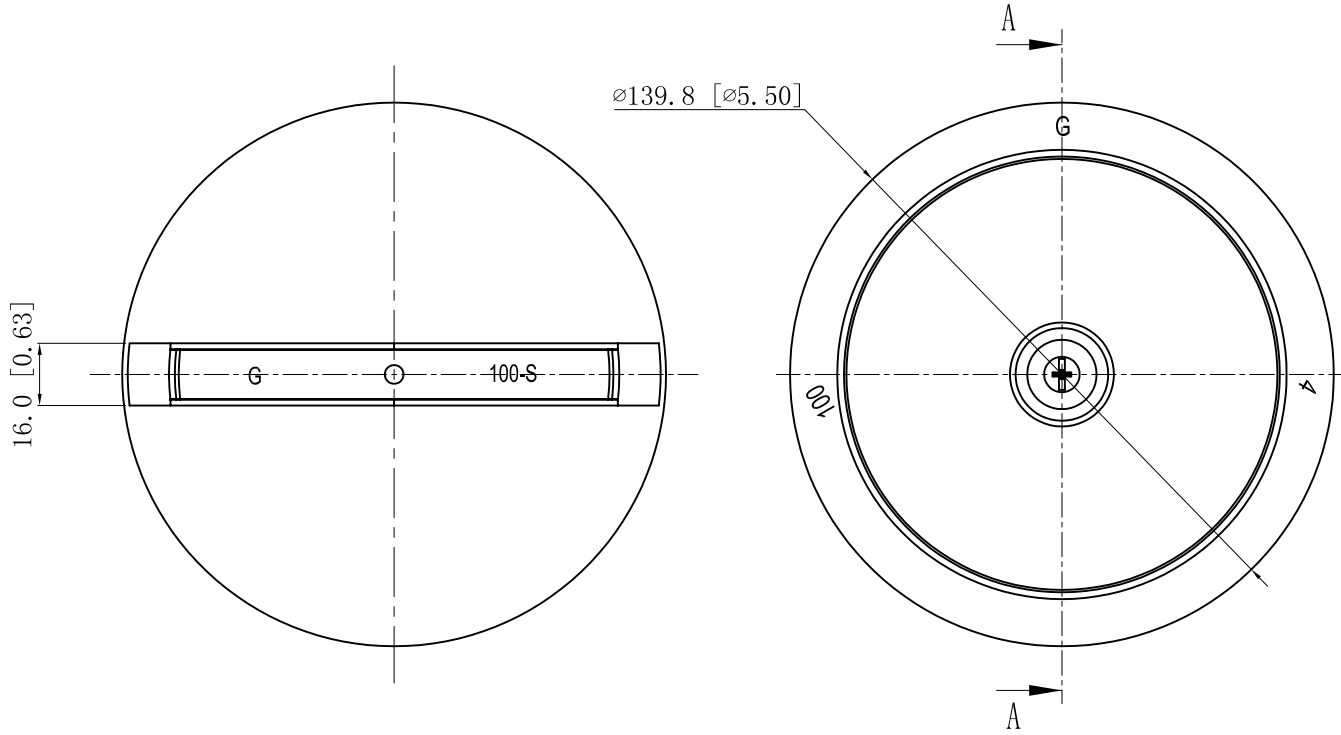

CUTAWAY VIEW A-A

This data sheet is for reference only .GARVIN INDUSTRIES reserves the right to make changes to the design without prior notice.

DESCRIPTION
TRADE REFERENCE TERMS

STANDARD PACKING
5 PCS

GARVIN INDUSTRIES		
TITLE KNOCKOUT SEALS		
SIZE A4	DWG NO. KOS-400-VT	REV
DATA SHEET		