



Southwire™

TOOLS & EQUIPMENT

1-855-SWTOOLS
TOLL FREE TECHNICAL HELP
Línea de Ayuda Técnica Gratuita

Contents Made in China/Fabriqué en Chine
Product distributed by/Produit distribué par
Southwire Company, LLC.
One Southwire Drive, Carrollton, GA 30119
©2018 Southwire Company, LLC.
All rights reserved. Tous droits réservés.

21510N manual/manuel



Southwire™

TOOLS & EQUIPMENT

Operating Instructions 21510N 400A AC Clamp Meter

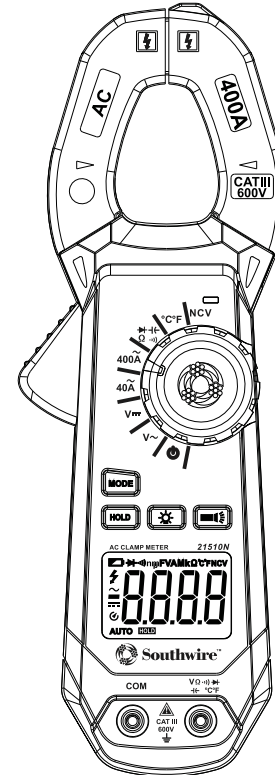

Introduction

The Southwire 21510N AC clamp meter is an electrical test tool that combines a digital clamp meter with an AC current sensor. The hinged jaw on the clamp meter is the current sensor. When electrical current flows through a wire, a magnetic field is generated around the wire. The current sensor detects and measures this magnetic field. A clamp meter is a convenient test & measurement tool because it allows a technician to measure the current in a wire at any point in an electrical system without having to disconnect the wire or deenergize the circuit. The Southwire 21510N clamp meter measures AC current up to 400A and offers a CAT III 600V safety rating. Other functions include AC and DC voltage, resistance, continuity, capacitance, temperature, and diode test. A built-in non-contact AC voltage detector, bright flashlight, and a “third-hand” test probe holder provide added convenience. This meter is fully tested and calibrated and, with proper use, will provide many years of reliable service.

⚠️ WARNINGS

- Read, understand and follow Safety Rules and Operating Instructions in this manual before using this meter.
- The meter’s safety features may not protect the user if not used in accordance with the manufacturer’s instructions.
- Ensure that the test leads are fully seated in the input jacks and keep fingers behind the finger guards when taking measurements.

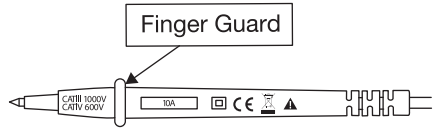

- Before changing functions using the selector switch, always disconnect the test leads from the circuit under test.
- Use only UL listed test leads with the proper safety category rating.
- Comply with all safety codes. Use approved personal protective equipment when working near live electrical circuits - particularly with regard to arc-flash potential.
- Use caution when working on or near bare conductors or bus bars.
- Use caution on live circuits. Voltages above 30 V AC RMS, 42 V AC peak, or 60 V DC pose a shock hazard.
- Do not use meter or test leads if they appear damaged.
- Do not use the meter in wet or damp environments or during electrical storms.
- Do not use the meter near explosive vapors, dust or gasses.
- Do not use the meter if it operates incorrectly. Protection may be compromised.
- Do not operate meter while Low Battery warning is on. Replace the batteries immediately.
- Verify meter’s operation by measuring a known voltage.
- Do not apply voltage or current that exceeds the meter’s maximum rated input limits.





Input Limits

Function	Maximum Input
Amperage AC	400A AC
Voltage AC, Voltage DC	600V AC / 600V DC
Resistance, Diode Test, Continuity	600V AC / 600V DC
Temperature (°C/°F)	600V AC / 600V DC

General Specifications

Clamp jaw opening	1.2" (30.5mm)
Insulation	Class 2, Double insulation.
Display	4000 count backlit LCD
Polarity	Minus symbol “-“ is displayed for negative polarity
Over Range Indication	“OL” is displayed
Diode Test	Test current approx. 1mA, open circuit voltage approx. 3V
Continuity Test	Audible beeper sounds if resistance is approx. 50Ω or less
Low Battery Indication	“  ” is displayed
Measurement Rate	3 times per second, nominal
Auto Power Off	After approx. 15 minutes of inactivity
Input Impedance	AC/DC voltage: ≥10MΩ
AC Response	Average Responding
AC Bandwidth	AC voltage: 50 to 400Hz, AC current: 50 to 60Hz
Battery	Three AAA batteries
Operating Temperature	32° to 104°F (0°C to 40°C)
Storage Temperature	14° to 122°F (-10°C to 50°C)
Relative Humidity	Maximum, non-condensing: 95% up to 82°F (28°C), 75% to 104°F (40°C), 45% to 122°F (50°C)
Operating Altitude (Maximum)	0-2000 meters
Weight	299.5g (including three AAA batteries)
Dimensions	8.5" x 2.9" x 1.6" (216 x 74 x 41mm)
Safety	UL: 61010 - 1:2012, 61010-2-032: 2014, 61010-2-033: 2014 EMC: EN61326-1:2013, EN61326-2-2:2013

International Safety Symbols

	Potential danger. Indicates the user must refer to the manual for important safety information.
	Indicates hazardous voltages may be present
	Equipment is protected by double or reinforced insulation
	Indicates the terminal(s) so marked must not be connected to a circuit where the voltage with respect to earth ground exceeds the maximum safety rating of the meter.
	Indicates the terminal(s) so marked may be subjected to hazardous voltages.

Safety Category Ratings

Category Rating	Brief Description	Typical Applications
CAT II	Single phase receptacles and connected loads	<ul style="list-style-type: none"> - Household appliances, power tools - Outlets more than 30ft (10m) from a CAT III source - Outlets more than 60ft (20m) from a CAT IV source
CAT III	Three phase circuits and single phase lighting circuits in commercial buildings	<ul style="list-style-type: none"> - Equipment in fixed installations such as 3-phase motors, switchgear and distribution panels - Lighting circuits in commercial buildings - Feeder lines in industrial plants - Any device or branch circuit that is close to a CAT III source
CAT IV	Connection point to utility power and outdoor conductors	<ul style="list-style-type: none"> - Primary distribution panels - Overhead or underground lines to detached buildings - Incoming service entrance from utility - Outdoor pumps

The measurement category (CAT) rating and voltage rating is determined by a combination of the meter, test probes and any accessories connected to the meter and test probes. The combination rating is the LOWEST of any individual component.

⚠ WARNING: Operation is limited to CAT II applications when the insulated tips are **removed** from one or both test probes. Refer to Input Limits section of this manual for maximum voltage ratings.

General Specifications cont.

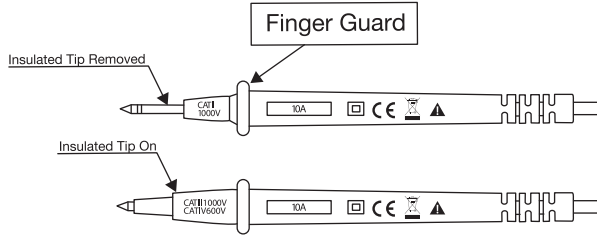

When insulated tip on, the test leads are CATIII 1000V, CATIV, 600V;
When insulated tip removed, the test leads are CATII 1000V.

Maintenance

This Clamp Meter is designed to provide years of dependable service, if the following care instructions are performed:

1. Keep the meter dry. If it gets wet, wipe it off.
2. Use and store the meter in normal temperatures. Temperature extremes can shorten the life of the electronic parts and distort or melt plastic parts.
3. Handle the meter gently and carefully. Dropping it can damage the electronic parts or the case.
4. Keep the meter clean. Wipe the case occasionally with a damp cloth. Do not use chemicals, cleaning solvents, or detergents.
5. Use only fresh batteries of the recommended size and type. Remove old or weak batteries so they do not leak and damage the unit.
6. If the meter is to be stored for a long period of time, the batteries should be removed to prevent damage to the unit.

Operation

Low Battery Indicator

The Low Battery Indicator " will appear on the LCD display when the batteries need replacement. Replace the batteries immediately to insure accurate and reliable operation. If the battery voltage falls below the minimum recommended level, the clamp meter beeper will beep four times and the meter will shut down. Replace the batteries to restore operation.

High Voltage Warning

When measuring voltage, the high voltage symbol " " will appear on the display if the voltage equals or exceeds 30V. Use caution on live circuits. Voltages above 30 VAC RMS, 42 VAC peak, or 60 VDC pose a shock hazard.

Auto Power Off

Whenever the clamp meter is on, you will notice the Auto Power Off or APO symbol  displayed in the lower left corner of the LCD screen. This symbol means that the APO function is active. The APO function helps conserve battery life. The APO function works as follows: After approximately 14 minutes of inactivity, the meter will beep 5 times indicating that Auto Power Off or APO is about to occur. After approximately 15 minutes of inactivity, the meter will beep once and then turn off. If APO turns the meter off, you can turn the meter back on by momentarily pressing the MODE, HOLD or Backlight button.

MODE Button



The **MODE** button is used to activate secondary functions of the clamp meter. Secondary functions are those which are shown in red lettering on the meter dial. To use a secondary function, turn the clamp meter dial to the function location and press the **MODE** button until the function symbol is displayed on the LCD screen. Secondary functions include Resistance, Diode Test, Capacitance and °C temperature.

Operation

HOLD Button

To freeze the reading on the LCD display, momentarily press the HOLD button. The "HOLD" indicator **HOLD** will appear on the LCD display. Momentarily press the HOLD button again to return to normal operation. The HOLD value will be lost if the position of the meter dial is changed or the meter is turned off.

LCD Backlight Button

The backlight illuminates the LCD display when the ambient light is too low to view the displayed readings. To turn the backlight on, press the  button. To turn off the backlight, press the  button.

NOTE: The backlight stays for approximately 30 seconds when the meter is initially turned on.

Flashlight button

Momentarily press the  button to turn the flashlight on and off.

AC Current Measurements

⚠ WARNINGS: Disconnect the test leads from the meter before making current clamp measurements. Do not measure current on conductors that more than 600V above earth ground. Observe safety precautions when working on live circuits.

1. Set the rotary function switch to **40A or 400A** position.
2. Press the trigger to open the jaw. Clamp around a single conductor making sure the jaws are fully closed before taking a measurement. For best results, keep the conductor centered inside the jaw. Small arrows molded into the clamp jaw indicate the optimum placement of the wire.
3. Read the current on the LCD display.

Operation cont.

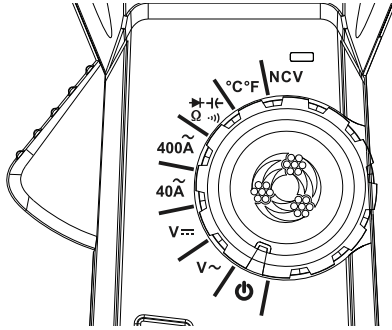

When measuring current on a 1-phase, 2-wire circuit, the clamp meter should be placed around one (not both) of the wires. See illustration below. Appliance and lamp power cords have two insulated wire conductors: the hot or live conductor and the neutral and ground conductors. Installing a clamp meter around both conductors will result in a reading of approximately zero amps because the current flowing through the live or hot wire will effectively cancel out the current flowing back through the neutral and ground wires. The Southwire 60040S AC line splitter conveniently separates the hot from the neutral and ground conductors, eliminating the need to physically separate the wires.

Operation cont.

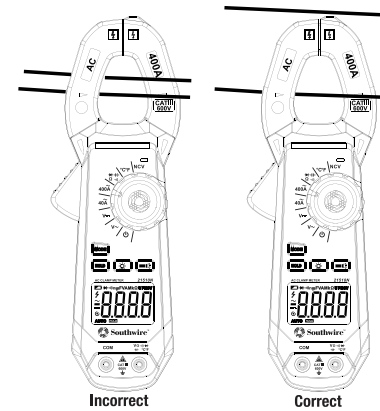

AC Voltage Measurements

⚠ WARNING: Observe all safety precautions when working on live voltages.

1. Set the rotary function switch to the **V~** position.
2. Insert the black test lead into the **COM** input jack and the red test lead into the **V** input jack.
3. Touch the test lead probes to the circuit under test.
4. Read the voltage on the LCD display.



Operation cont.

DC Voltage Measurements

⚠ WARNING: Observe all safety precautions when working on live voltages.

1. Set the rotary function switch to the **V_{DC}** position.
2. Insert the black test lead into the **COM** input jack and the red test lead into the **V** input jack.
3. Touch the test lead probes to the circuit under test. Touch the red test lead to the positive side of the circuit and the black test lead to the negative side of the circuit.
4. Read the voltage on the LCD display.



Continuity Test

⚠ WARNING: Never test continuity on a live circuit.

Continuity is represented by the symbol **•|)**. Continuity is a resistance measurement so the symbol for resistance Ω is also displayed.

1. Set the rotary function switch to the **•|)** position.
2. If necessary, press the MODE button until the **•|)** symbol appears on the top of the display.
3. Insert the black test lead into the COM input jack and the red test lead into the **•|)** input jack.
4. The LCD display will show "OL" which means that an open circuit condition exists. This is normal since the test lead probes are not yet

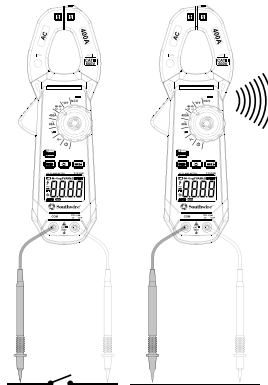

Operation cont.

connected to anything.

5. Touch the test lead probes to the device or wire under test.
6. A beeper will sound if the resistance is approximately 50Ω or less and the resistance value will be shown on the LCD display

Resistance Measurements

⚠ WARNING: Never test resistance on a live circuit.

1. Set the rotary function switch to the Ω position.
2. Press the MODE button until the " Ω " symbol appears on the display. Either $k\Omega$ or $M\Omega$ will be displayed. Make sure you have not selected the Continuity mode. You are in the Continuity mode when the Continuity symbol **•|)** is displayed.
3. Insert the black test lead into the COM input jack and the red test lead into the Ω input jack.
4. The LCD display will show "OL" which means that an open circuit condition exists. This is normal since the test lead probes are not yet connected to anything.
5. Touch the test lead probes to the component under test. If the component is installed in a circuit, it is best to disconnect one side before testing to eliminate interference from other devices.
6. Read the resistance on the LCD display.



Operation cont.

Diode Test

WARNING: Never test diodes on a live circuit.

1. Set the rotary function switch to the \rightarrow position.
2. Press the MODE button until the “ \rightarrow ” symbol appears on the display.
3. Insert the black test lead into the COM input jack and the red test lead into the \rightarrow input jack.
4. Touch the test lead probes to the diode under test.
5. Forward voltage will indicate 0.4V to 0.7V on the LCD display. Reverse voltage will indicate “OL”. Shorted devices will indicate near 0V and an open device will indicate “OL” in both polarities.

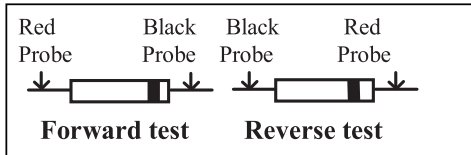

Operation cont.

Capacitance Test

WARNING: Safely discharge capacitors before taking capacitance measurements

1. Set the rotary function switch to the $\text{---}||\text{---}$ position.
2. Press the MODE button until the nF symbol appears on the display.
3. Insert the black test lead into the COM input jack and the red test lead into the $\text{---}||\text{---}$ input jack.
4. Touch the test lead probes to the capacitor under test.
5. Read the capacitance value on the LCD display.
It may take up to a minute to get a stable reading on large capacitors.

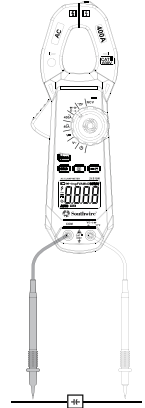

Temperature Measurements

WARNING: Do not touch the temperature probe to live circuits.

1. Set the rotary function switch to the $^{\circ}\text{C}$ $^{\circ}\text{F}$ position.
2. Press the **MODE** button to select readings in $^{\circ}\text{F}$ or $^{\circ}\text{C}$.
3. Insert the yellow temperature probe plug to the Banana Plug Adapter. Be certain when you insert the temperature probe plug into the banana plug adapter that the positive (+) pin on the yellow temperature probe connector is inserted into the positive (+) socket on the banana plug adapter.
4. Connect the banana plug adapter to the meter, making sure the negative (–) or black side goes into the COM input jack and the positive (+) or red side goes into the $^{\circ}\text{C}$ $^{\circ}\text{F}$ input jack.
5. Touch the tip of the Temperature Probe to the



Operation cont.

object being measured. Keep the probe touching the object until the reading stabilizes (about 30 sec).

6. Read the temperature on the LCD display.

 **WARNING:** To avoid electric shock, remove the temperature probe before changing to another measurement function.

Non-Contact AC Voltage (NCV) Detector (50V to 600V AC, 50Hz/60Hz detection range)

 **WARNING:** Risk of electrocution. Before use, always test the Non-Contact AC Voltage Detector on a known live circuit to verify proper operation.

WARNINGS:

- Read, understand and follow safety rules and operating Instructions in the manual before using the non-contact voltage detector feature of this clamp meter.
- The non-contact voltage detector simply detects the presence of voltage – it will not measure and display the voltage on the LCD screen.
- The clamp meters safety features may not protect the user if not used in accordance with the manufacturer's instructions.
- Test operation of the NCV detector on a known live source within the rated AC voltage range of the detector before use to ensure it is working correctly.
- Insulation type and thickness, electrical outlet design, detector distance from the voltage source, shielding, and other factors may affect reliable operation. Use other methods to verify live voltage if there is any uncertainty.
- The detector will not detect voltage if:
 - The voltage is DC
 - The wire is shielded or in a grounded metal box or conduit
 - The user is not grounded or is isolated from earth ground

Operation cont.

- The detector may not detect voltage if:
 - The detector tip cannot be fully inserted into the electrical outlet
 - The electrical outlet is a Tamper Resistant (TR) design
 - The user is not holding the detector or the user's hand is insulated from the detector (i.e. with a glove)
 - The voltage source or wire is partially buried
 - The magnetic field created by the voltage source is being blocked or interfered with
 - The frequency of the voltage being detected is distorted and thus not a perfect sine wave
- The LED indicators may not be visible in direct sunlight or very bright light conditions
- Do not use if the meter appears damaged or if it is not operating properly.
- Do not use on voltages that are outside of the 50V AC to 600V AC detection range.
- Use caution with voltages above 30 volts AC as a shock hazard may exist.
- Comply with local and national safety requirements – particularly with regard to arc-flash potential.
- Do not operate the NCV detector if the clamp meter Low Battery indicator is displayed. Replace the batteries immediately.
- Do not use the NCV detector if there is evidence that the meter batteries have leaked. Detector may be compromised.
- Use approved personal protective equipment when working on live circuits.

NCV OPERATION:

1. Set the rotary function switch to the NCV position.

The detector does not operate when Auto Power Off (APO) turns the meter off or when the rotary function switch is set to any other position. The NCV function only operates when the function switch is turned to NCV position. "NCV" will be shown on the LCD display indicating the detector is ready for use.

Operation cont.

2. There is a small raised area on the top of the non-movable portion of the clamp meter jaw. The non-contact voltage detector is located beneath this raised area. Position this raised area near to an AC voltage source.
3. If AC voltage within the specified voltage range is present, the indicator light will illuminate and the beeper will sound.

NOTE: The detector is designed with high sensitivity. Static electricity and other sources of electrical energy may randomly activate the detector. This is normal operation.

NOTE: The detector only activates the indicator light when AC voltage is present. It does not indicate the voltage level on the LCD display.

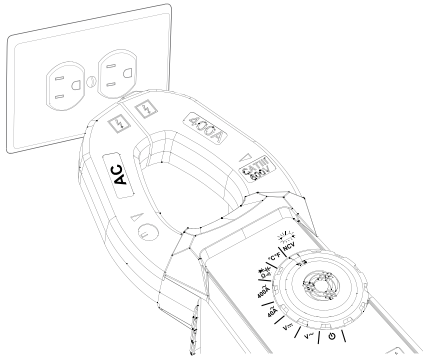
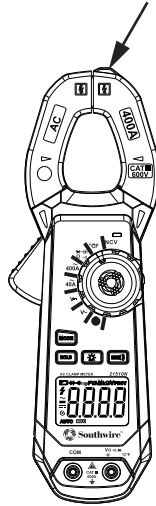

Operation cont.

Battery Replacement

⚠ WARNING: To avoid electric shock, remove the test leads from the meter before removing the battery cover.

1. When the battery is depleted, the  symbol will appear on the LCD display. Replace the battery immediately.
2. Use a small Phillips screwdriver to loosen the one screw.
3. Remove the battery cover,
4. Replace the batteries with three new AAA batteries.
5. Observe proper polarity as shown inside battery compartment.
6. Re-Install the battery cover and tighten the screw.

⚠ WARNING: To avoid electric shock, do not operate your meter until the battery and fuse covers are in place and fastened securely.

battery cover

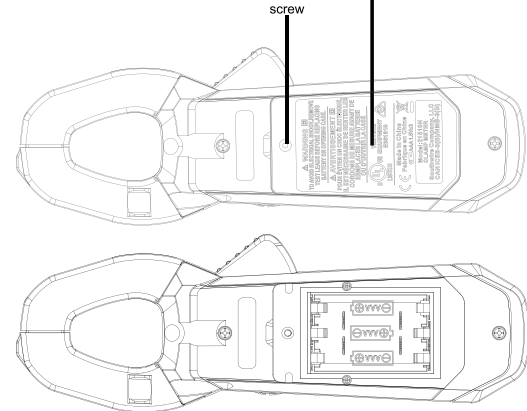

Specifications

Function	Range	Resolution	Accuracy (% of reading)
AC Current	40.00A	10mA	±(2.0% +9 digits)
	400.0A	0.1A	
	All ranges are specified from 10% to 100% of range		
	Bandwidth: 50Hz to 60Hz		
AC Voltage	4.000V	1mV	±(1.0% +5 digits)
	40.00V	10mV	
	400.0V	0.1V	
	600V	1V	
	All ranges are specified from 10% to 100% of range		
Bandwidth: 50Hz to 400Hz			
DC Voltage	400.0mV	0.1mV	±(1.0% +8 digits)
	4.000V	1mV	±(1.0% +3 digits)
	40.00V	10mV	
	400.0V	0.1V	
	600V	1V	±(1.2% +3 digits)
	All ranges are specified from 5% to 100% of range		
Resistance	400.0 Ω	0.1 Ω	±(1.0% +4 digits)
	4.000k Ω	1 Ω	±(1.2% +5 digits)
	40.00k Ω	10 Ω	
	400.0k Ω	100 Ω	
	4.000M Ω	1k Ω	±(2.0% +5 digits)
	40.00M Ω	10k Ω	±(2.0% +10 digits)
All ranges are specified from 10% to 100% of range			

Specifications

Function	Range	Resolution	Accuracy (% of reading)
Capacitance	400.0nF	0.1nF	±(3.0% + 5 digits)
	4.000μF	1nF	
	40.00μF	10nF	
	400.0μF	0.1μF	±(5.0% + 5 digits)
	1000μF	1μF	
All ranges are specified from 10% to 100% of range			
Temperature	-5 to 750°F	1° F	±(3.0% + 6°F)
	-20° to 400°C	1° C	±(3.0% + 3°C)

NOTE: Accuracy is stated at 64°F to 82°F (18°C to 28°C) and less than 75% RH.

“Third-Hand” Test Probe Holder

Your Southwire 21510N clamp meter was designed with a “third hand” test probe holder on the back of the clamp jaw. The “third hand” test probe holder allows you to hold the clamp meter & a test probe in one hand while holding the second test probe in your other hand. It’s like having a “third hand” when taking measurements.

Accessories

To view available accessories for your new clamp meter, visit southwiretools.com

Customer Service

For technical questions related to your clamp meter or information on how to purchase fuses or Southwire accessories, contact Southwire Customer Service at 1-855-SW-TOOLS

Professional Meter Calibration

For information on Southwire’s meter calibration service, visit our website at southwiretools.com. Once there, click on the Test and Measurement page. Then find the product page for your meter. There you’ll find a link to our Meter Calibration service.

PRODUCT COMPLIANCE



Users of this product are cautioned not to make modifications or changes that are not approved by Southwire Company, LLC. Doing so may void the compliance of this product with applicable laws and regulatory requirements and may result in the loss of the user's authority to operate the equipment.

UNITED STATES AND CANADA

This device complies with Part 15 of the FCC Rules. Operation is subject to the following two conditions; (1) This device may not cause harmful interference, and (2) this device must accept any interference received, including interference that may cause undesired operation.

This equipment has been tested and found to comply with the limits for a Class B digital device, pursuant to Part 15 of the FCC Rules. These limits are designed to provide reasonable protection against harmful interference in a residential installation. This equipment generates uses and can radiate radio frequency energy and, if not installed and used in accordance with the instructions, may cause harmful interference to radio communications. However, there is no guarantee that interference will not occur in a particular installation. If this equipment does cause harmful interference to radio or television reception, which can be determined by turning the equipment off and on, the user is encouraged to try to correct the interference by one or more of the following measures:

- Reorient or relocate the radio or television receiving antenna.
- Increase the separation between the computer equipment and receiver.
- Connect the equipment into an outlet on a circuit different from that to which the radio or television receiver is connected.
- Consult the dealer or an experienced radio television technician for help.

CAUTION: To comply with the limits of the Class B device, pursuant to Part 15 of the FCC Rules, this device is to comply with Class B limits. All peripherals must be shielded and grounded. Operation with non-certified peripherals or non-shielded cables is likely to result in interference and reception of the device.

Canadian Digital Apparatus Compliance
CAN ICES-3(B)/NMB-3(B)

EUROPEAN UNION

In accordance with CE requirements, the Declaration of Conformity may be found at www.southwiretools.com

REGISTER YOUR PRODUCT

Register your product purchase at www.southwiretools.com.

At Southwire, we are dedicated to providing you with the best customer experience. By following a few quick steps to register, you can experience quicker service, more efficient support, and receive information on our future products. Simply provide your model number, serial number, and just a few pieces of information about yourself – it is that quick and easy.

LIMITED WARRANTY AND LIMITATION OF LIABILITY ON SOUTHWIRE METERS & TESTERS

Southwire Company, LLC, warrants this product to be free from defects in material and workmanship for five years from the date of purchase. This warranty does not cover fuses, disposable batteries, or damage arising from an accident, neglect, misapplication, contamination, modification, improper maintenance or repair, operation outside of specifications, or abnormal handling of the product.

exclusive remedy, for any breach of this warranty is expressly limited to Southwire's repair or replacement of the product. Whether Southwire repairs or replaces the product will be a determination that Southwire makes at its sole discretion.

SOUTHWIRE MAKES NO WARRANTY THAT THE PRODUCT WILL BE MERCHANTABLE OR FIT FOR ANY PARTICULAR PURPOSE. SOUTHWIRE MAKES NO OTHER WARRANTY, EXPRESSED OR IMPLIED, OTHER THAN THE WARRANTY SPECIFICALLY SET FORTH HEREIN. SOUTHWIRE WILL NOT BE LIABLE FOR ANY INCIDENTAL, CONSEQUENTIAL, INDIRECT, SPECIAL, OR PUNITIVE DAMAGES FOR ANY BREACH OF THIS WARRANTY.

This warranty is void if this product is used for rental purposes. No product reseller is authorized to extend any other warranty on Southwire's behalf relating to this product, and no such reseller warranty will be binding on Southwire. If you have a warranty claim, or if the product needs to be serviced during or after the warranty period set forth above, please contact the Customer Service Department at 855-SWTOOLS (855-798-6657). The sender is responsible for all shipping, freight, insurance, and packaging costs associated with sending a product to Southwire. Southwire will not be responsible for lost or damaged products returned pursuant to this warranty. All products returned to Southwire under this warranty should be mailed to:

Southwire Company, LLC.
Attention: Tool Warranty Return
840 Old Bremen Road
Carrollton, GA 30117