

CADDY MAC™ 1 PARTS (783398)

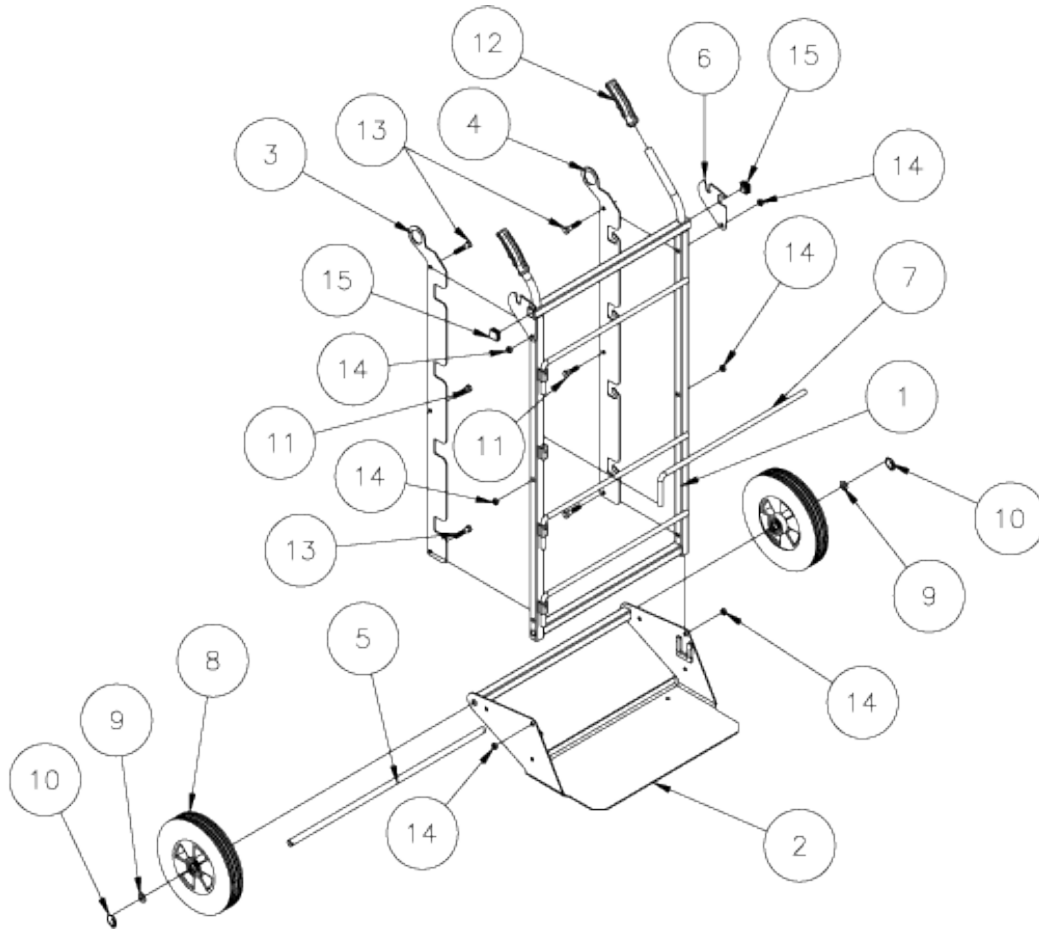

Item	Part No.	Description	Qty
1	783387	FRAME, WELDMENT (MODEL 1)	1
2	783393	PLATE, DOLLY WELDMENT (MODEL 1)	1
3	783380	PLATE, REAR STOP (MODEL 1 & 2)	1
4	783381	PLATE, REAR LOCK (MODEL 1 & 2)	1
5	783394	AXLE (MODEL 1, 2 & 3)	1
6	783399	PLATE, STORAGE LOCK (MODEL 1&2)	2
7	783396	SPINDLE (MODEL 1 & 2)	4
8	779011	WHEEL, 10" RUBBER TIRE	2
9	773051	WASHER, FLAT 5/8"	2
10	774054	COTTER, CIRCLE Z/P .072X 1 1/8"	2
11	771090	SCREW, HHC, 3/8-16 X 1-1/2"	2
12	779528	GRIP, HAND (BLACK) (MODEL 1&2)	2
13	771100	SCREW, HHC 3/8-16 X 1-3/4"	4
14	772350	NUT, INSERT JAM 3/8-16	6
15	779915	CAP, 1" SQUARE TUBING, BLK	2

CADDY MAC™ 2 PARTS (783395)

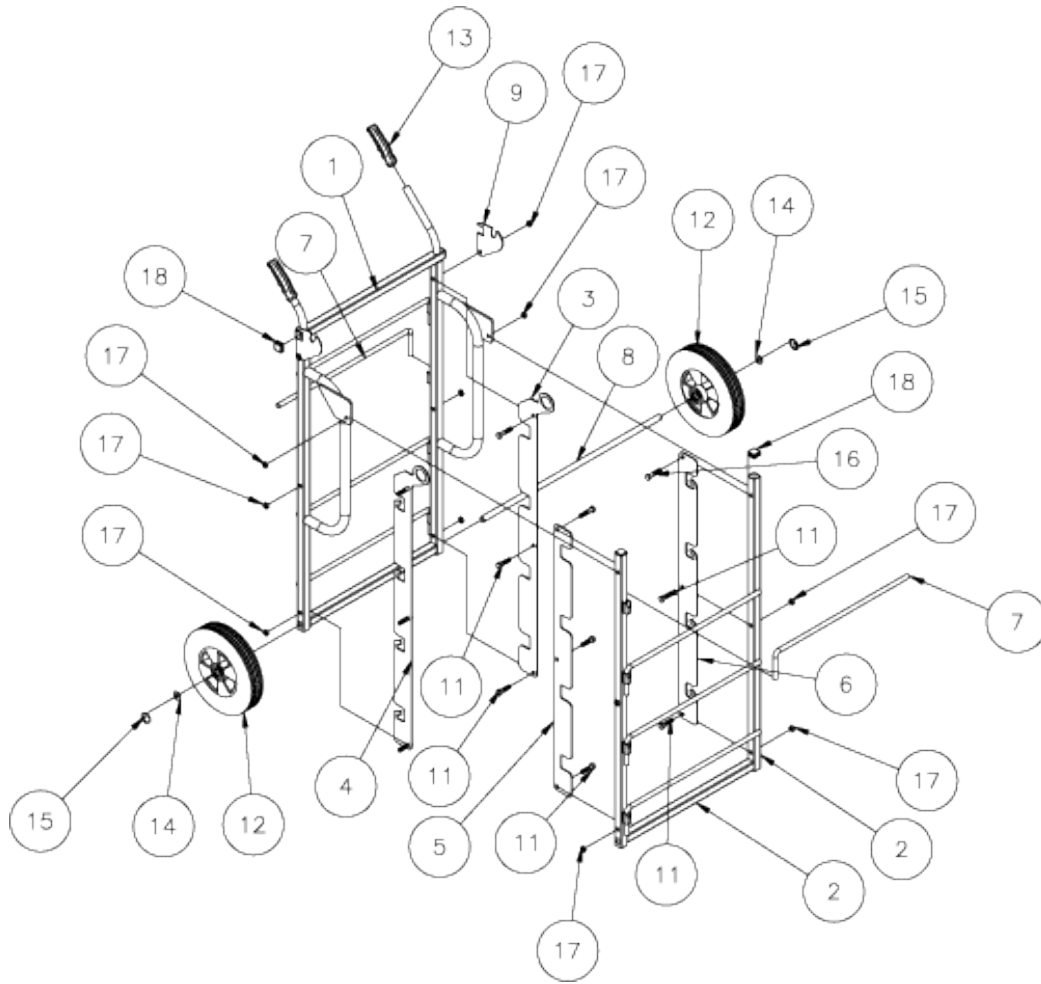

Item	Part No.	Description	Qty
1	783386	FRAME, REAR WELDMENT (MODEL 2)	1
2	783383	FRAME, BASIC WELDMENT (MODEL 2)	1
3	783380	PLATE, REAR STOP (MODEL 1 & 2)	1
4	783381	PLATE, REAR LOCK (MODEL 1 & 2)	1
5	783378	PLATE, FRONT STOP (MODEL 2)	1
6	783377	PLATE, FRONT LOCK (MODEL 2)	1
7	783396	SPINDLE (MODEL 1 & 2)	8
8	783394	AXLE (MODEL 1, 2 & 3)	1
9	783399	PLATE, STORAGE LOCK (MODEL 1&2)	2
11	771090	SCREW, HHC, 3/8-16 X 1-1/2"	8
12	779011	WHEEL, 10" RUBBER TIRE	2
13	779528	GRIP, HAND (BLACK) (MODEL 1&2)	2
14	773028	WASHER, FLAT, LARGE ID	2
15	774054	COTTER, CIRCLE Z/P .072X 1 1/8"	2
16	771100	SCREW, HHC 3/8-16 X 1-3/4"	4
17	772350	NUT, INSERT JAM 3/8-16	12
18	779915	CAP, 1" SQUARE TUBING, BLK	4

CADDY MAC™ 3 PARTS (783400)

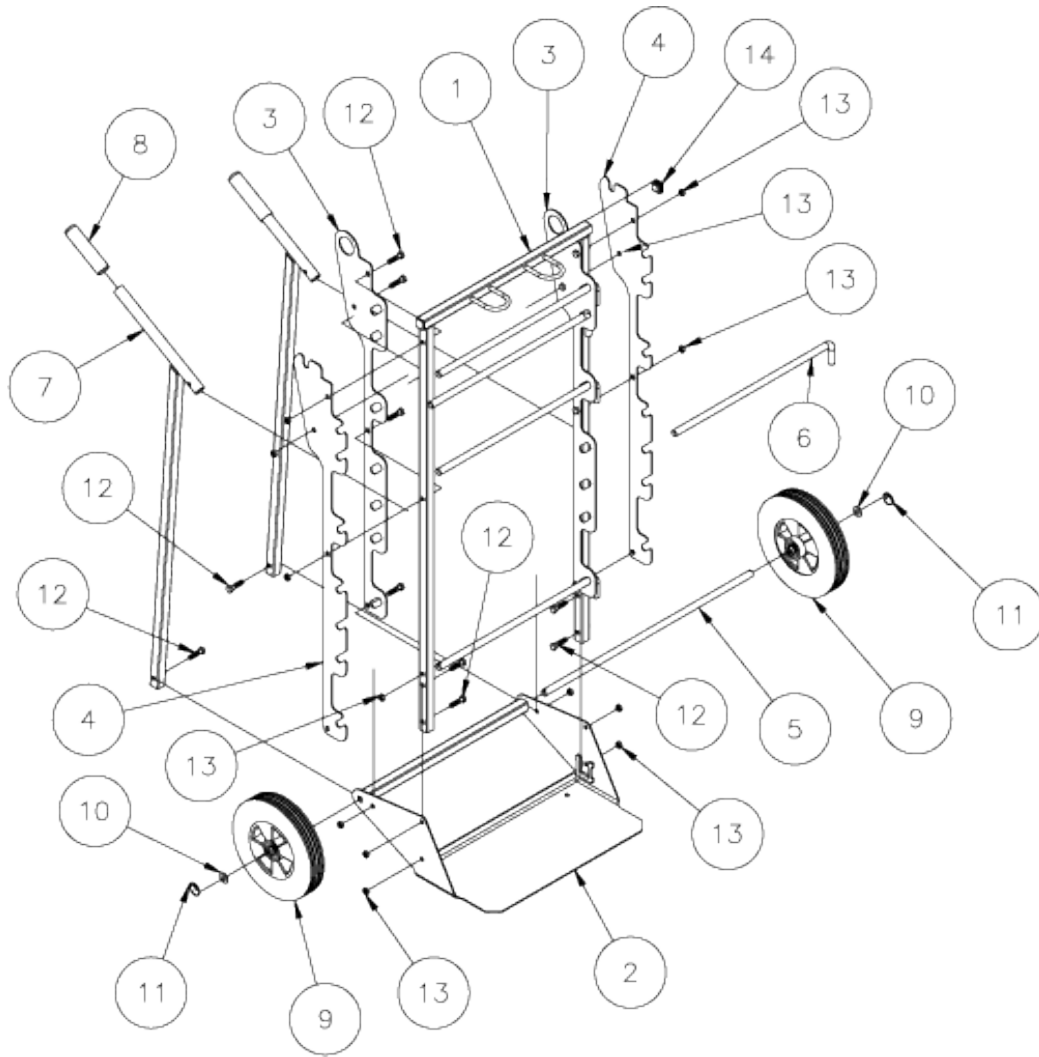

Item	Part No.	Description	Qty
1	783403	FRAME WELDMENT (MODEL 3)	1
2	783405	DOLLY PLATE WELDMENT (MODEL 3)	1
3	783406	PLATE, SPINDLE SLIDE (MODEL 3)	2
4	783407	PLATE, SPINDLE LOCK (MODEL 3)	2
5	783394	AXLE (MODEL 1, 2 & 3)	1
6	783409	SPINDLE, LARGE (MODEL 3)	5
7	783408	HANDLE WELDMENT (MODEL 3)	2
8	779527	GRIP HAND 1' ID X 5" LG	2
9	779011	WHEEL, 10" RUBBER TIRE	2
10	773028	WASHER, FLAT, LARGE ID	2
11	774054	COTTER, CIRCLE Z/P .072X 1 1/8"	2
12	771090	SCREW, HHC, 3/8-16 X 1-1/2"	14
13	772350	NUT, INSERT JAM 3/8-16	14
14	779915	CAP, 1" SQUARE TUBING, BLK	2