

SIDES	BOTTOM
Material: Steel-0.031"-G60 Galvanized	

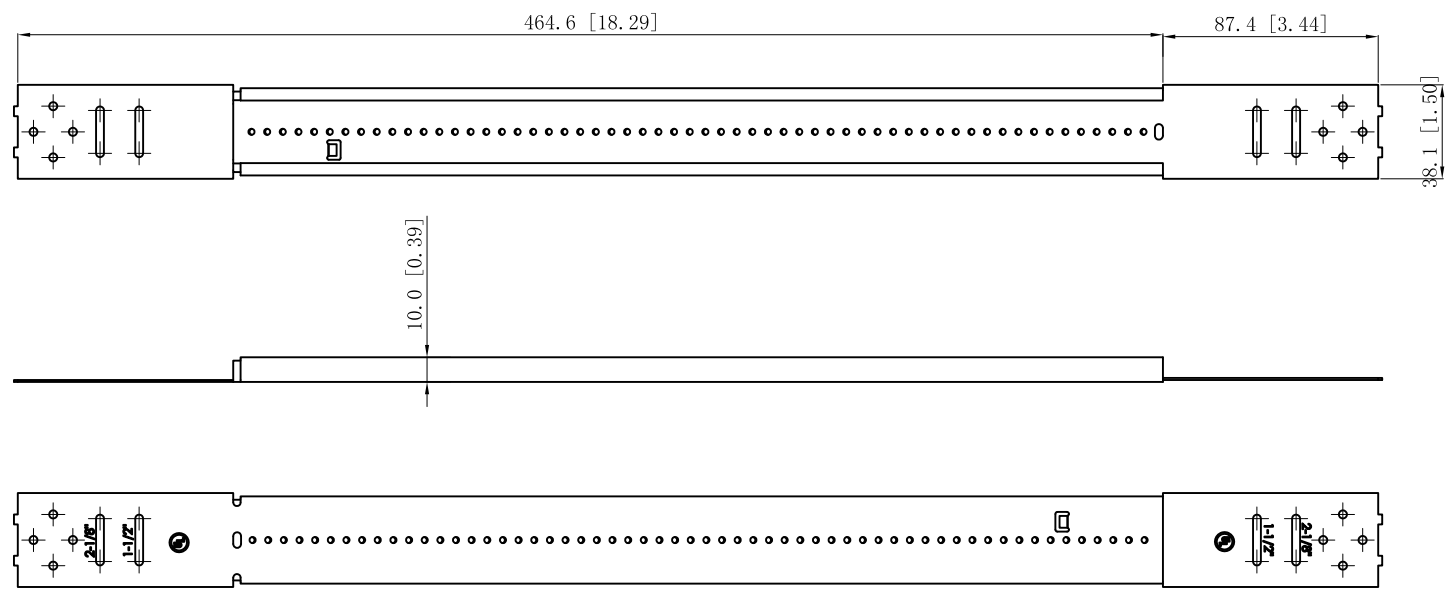
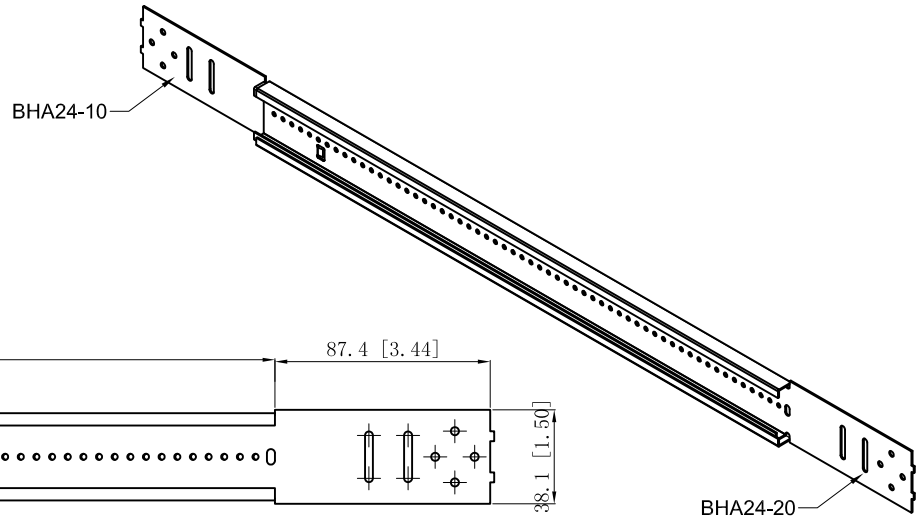

This data sheet is for reference only .GARVIN INDUSTRIES reserves the right to make changes to the design without prior notice.

DESCRIPTION
TRADE REFERENCE TERMS

STANDARD PACKING
50 PCS

GARVIN INDUSTRIES		
TITLE ADJUSTABLE LENGTH BOX BAR HANGERS		
SIZE A4	DWG NO. BHA24	REV B
DATA SHEET		