

Cable Replacement Instructions for Series 2311 & 2315 CE Cable Lifts

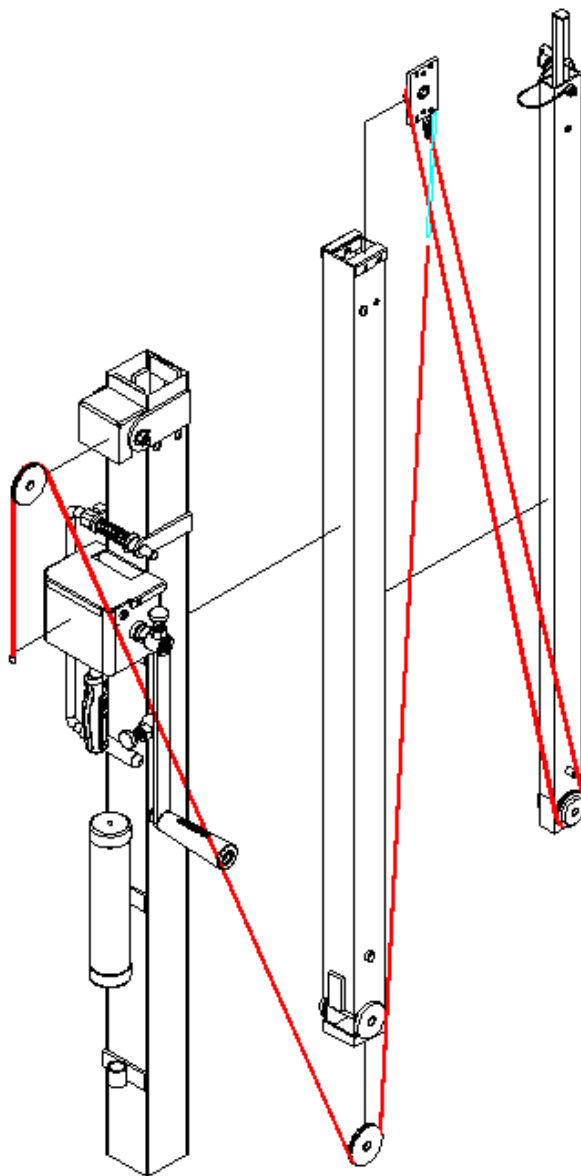

SUMNER

US
7514 Alabonson Road
Houston, TX 77088
phone: 281-999-6900
fax: 281-999-6966

Canada
75 Saltsman Drive, Unit 5
Cambridge, ON N3H 4R7
phone: 519-653-5300
fax: 519-653-5305

UK
Unit 16A
Blackpole Trading Estate East
Blackpole Road
Worcester WR3 8SG
phone: +44 (0) 1905 458333
fax: +44 (0) 1905 458222

Step 1



1. Remove cradle and base from mast assembly. Lay down mast assembly on a solid level work surface.

Step 2



2. Remove mast hold down assembly, (771055) screw and (772502) jam nut.

Step 3



3. Remove (776042) screws and (784408) pulley guard.

Step 4

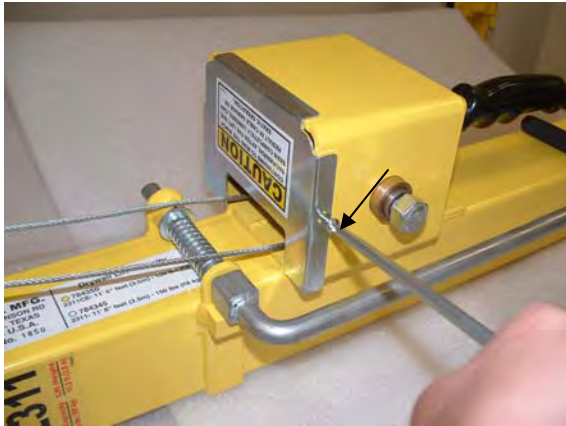

4. Remove (776042) screws and (774428) winch cover.

Step 5

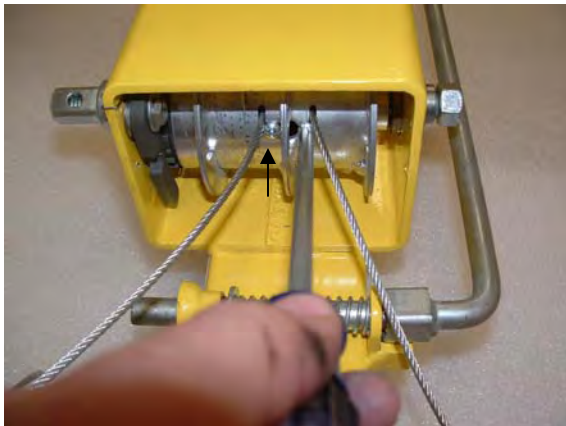

5. Remove (776042) screws from winch drum and remove cable as shown.

Step 6



6. Remove top outer mast components as shown.

Step 7

7. Remove (771044) screws and (784403) top cover from both sides of the center mast tube.

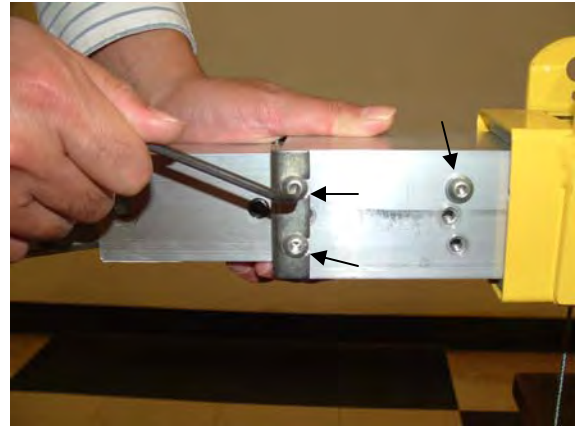

Step 8

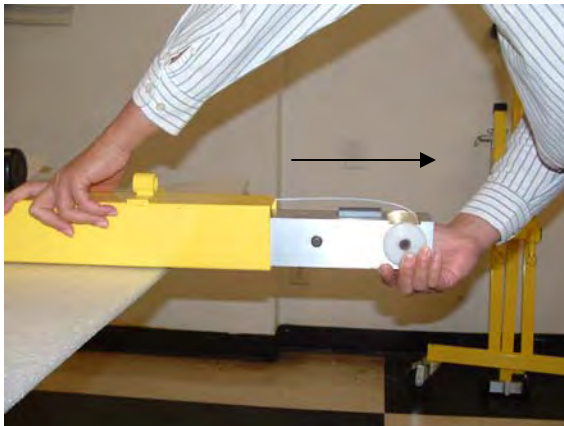

8. Remove center mast assembly from the bottom of the outer mast.

Step 9

9. Remove pulley, wear pad and other components from the bottom of the center mast.



Step 10

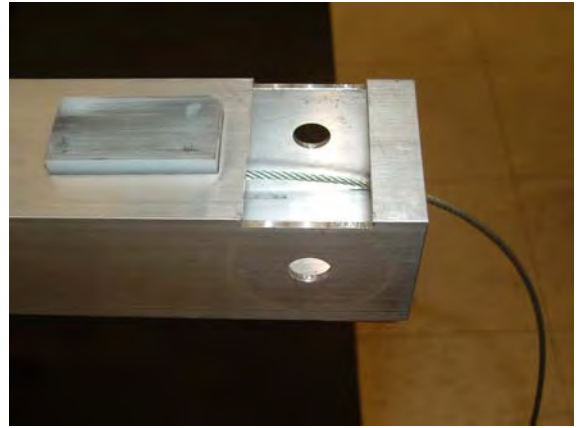
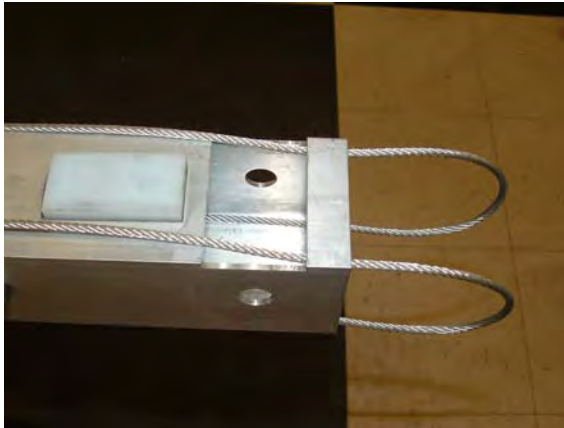

10. Pull cable from the loop position to a strait position through the bottom of the center mast for easy removal of top mast assembly.

Step 11

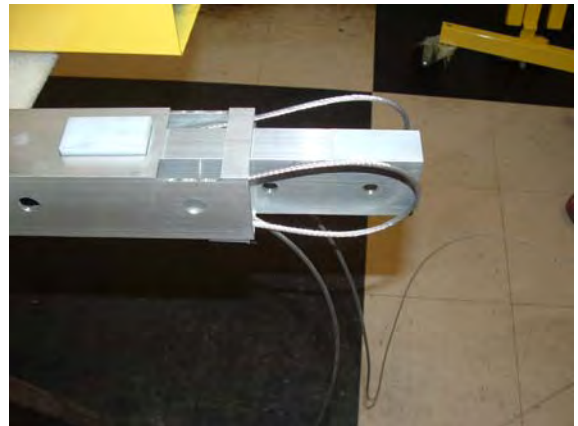

11. Pull top mast assembly slightly out the bottom mast of the center mast as shown and remove all components.

Step 12

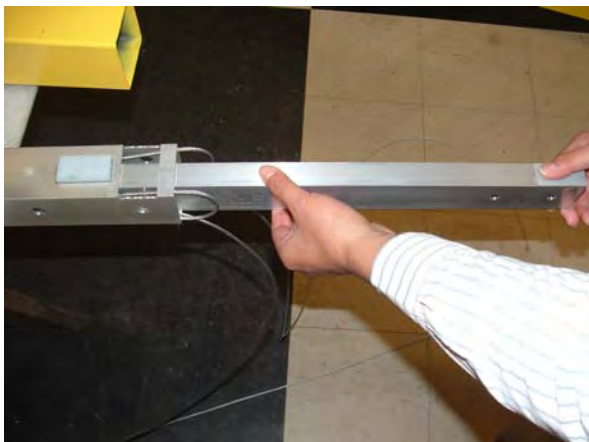

12. Remove top mast tube from center mast.

Step 13

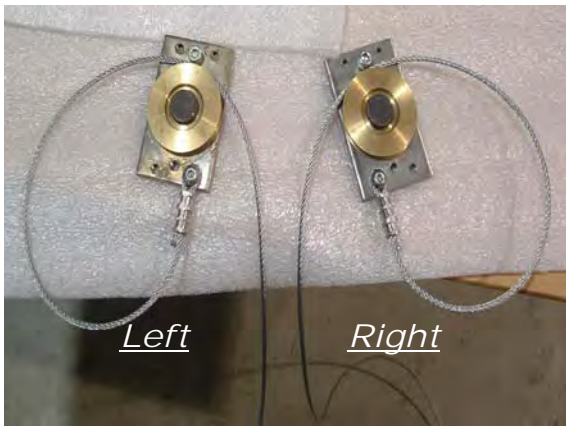
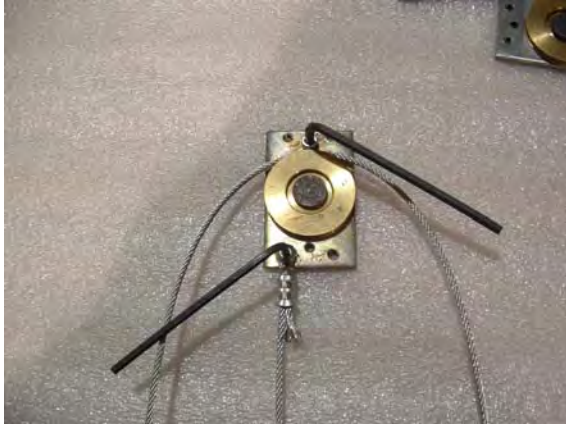

13. Remove (784399) center mast pulley weldments from center mast and replace damaged cable as shown.

**Make sure cable is attached to the pulley weldment in the correct hole location and loop the cable in the right direction for proper installation of the cable. (Make note of this position upon removal)*

Step 14



14. Lay down all mast sections on a solid level work surface. Make sure all components required to assemble the 2300 lift are at hand.

Step 15

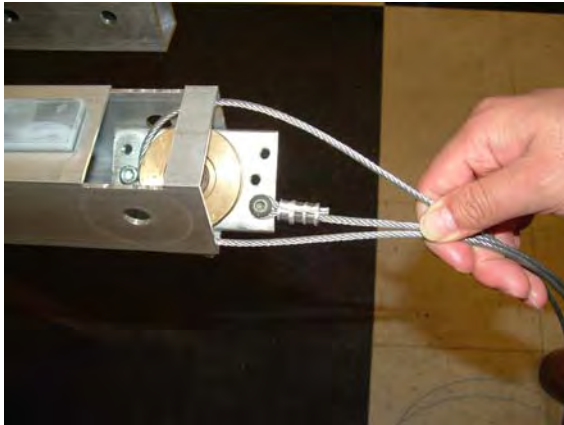

15. Insert (784398) center mast pulley weldments into the center mast tube (working from bottom) as shown. Refer to step 13, to distinguish left and right side pulley weldment.
* Give the cable the equal length of the center tube.

Step 16

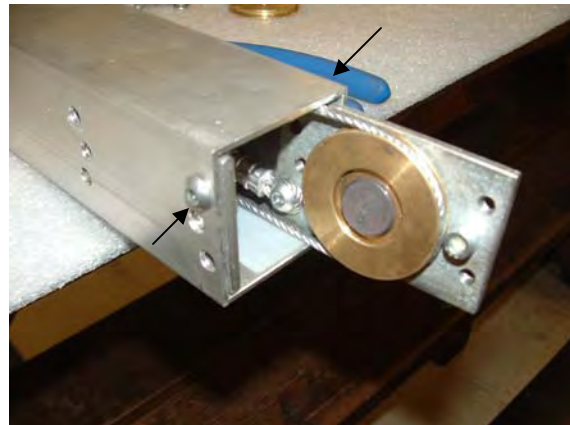
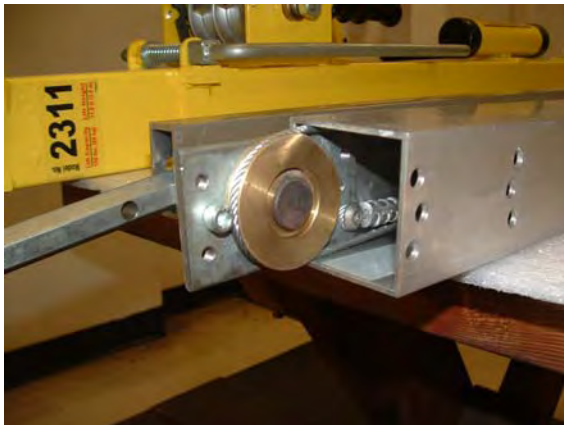

16. Locate (771044) screws and secure the (784399) center mast pulley weldments brackets on both sides as shown.



Step 17

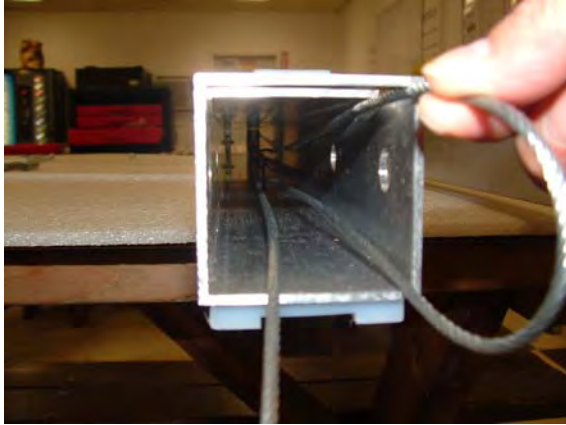

17. Straight cable on both sides as shown. Make sure cable is not tangle up inside the mast section.

Step 18

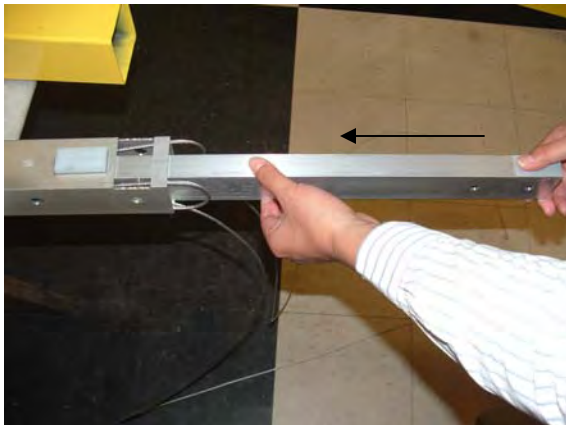

18. Insert top mast tube into center mast tube as shown.

Step 19



19. Locate (784412) top mast wear discs, (784391) 2 " pulleys and (774041) dowel pins.

Step 20

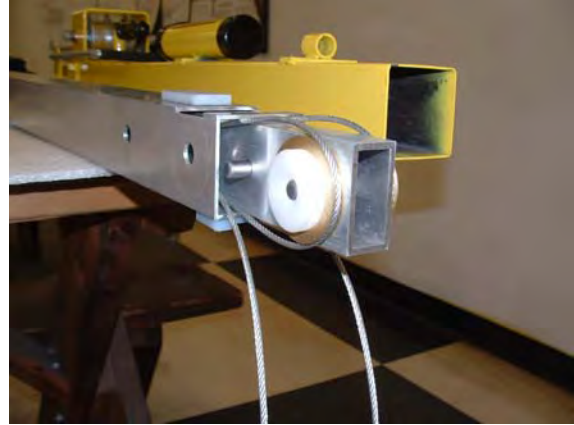
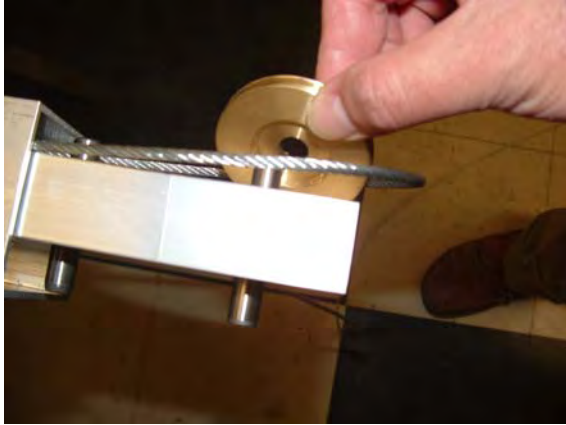

20. Assemble components from step 19 as shown.

Step 21

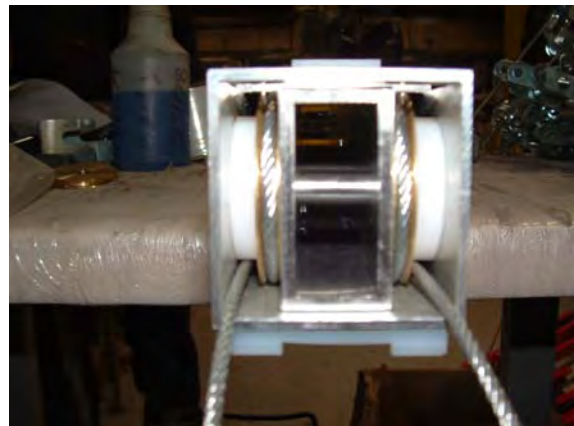
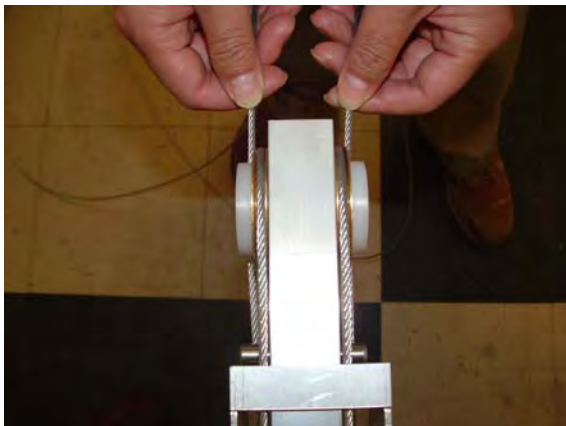

21. Insert top mast assembly into center mast tube by pulling both cables at the same time and stop when the end of the top mast passes the second hole of the center mast tube.

**Top mast should enter the center mast with ease, if there is stiffness check the cable and components for correct installation.*

Step 22

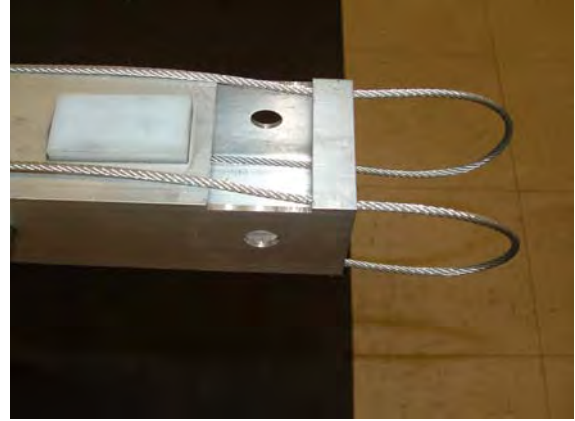
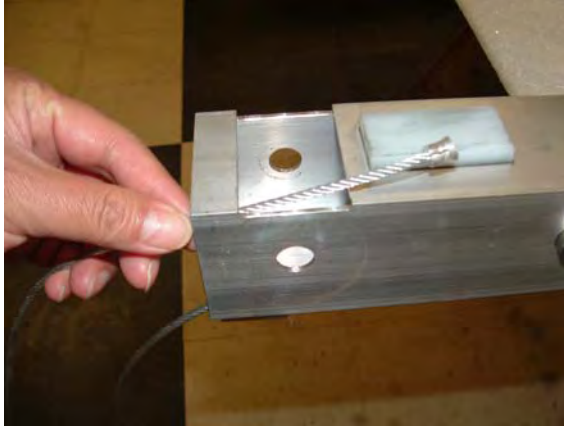

22. Insert and loop cable through the center mast slot as shown.

Step 23

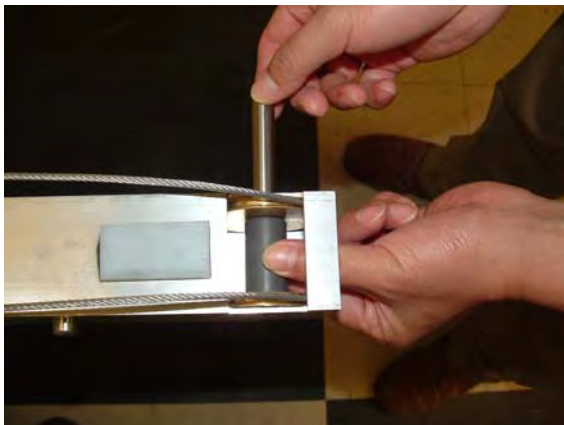
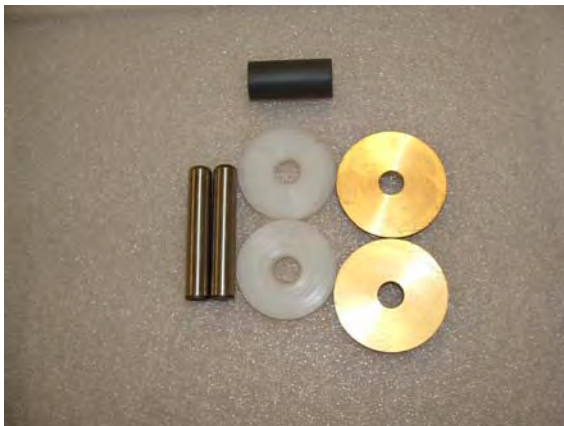

23. Locate (784404) center mast wear discs, (784390) 2-1/4" pulleys, (774043) dowel pins and (784447) 1-5/8" pulley spacer. Assemble components as shown.

Step 24

24. Remove (771044) both screws from center mast tube.

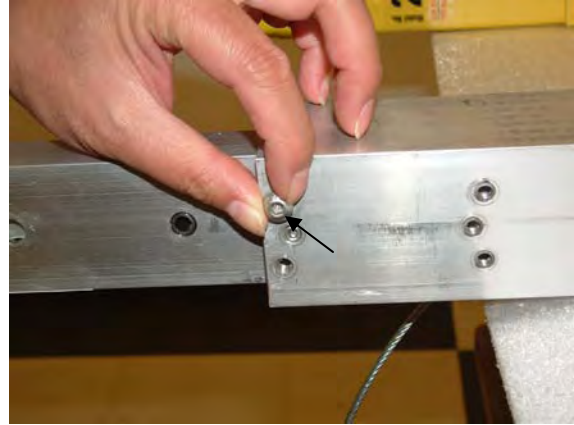

Step 25

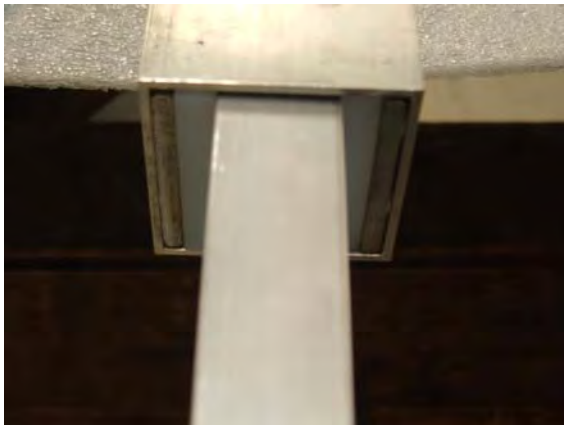

25. Insert (774452) wear pads into slots on both sides as shown.

Step 26

26. Insert center mast assembly into the bottom of the outer mast weldment.

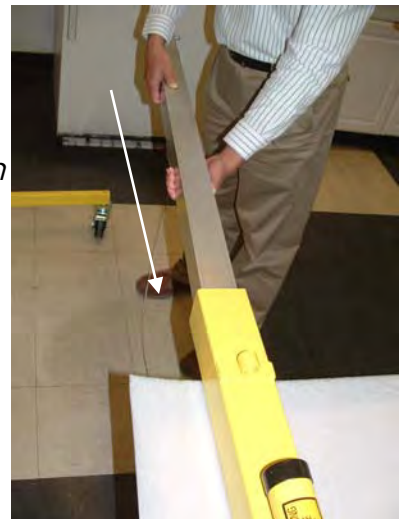

Step 27

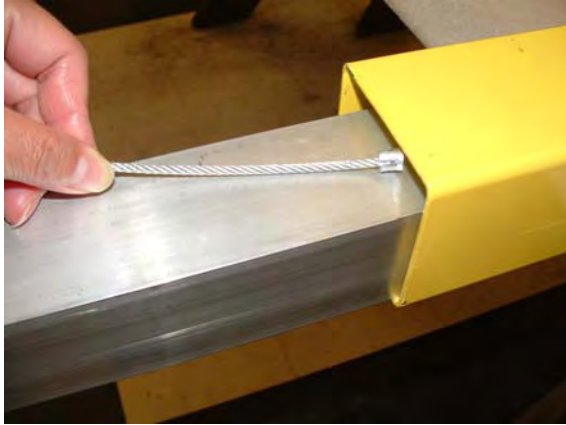

27. Insert both cables through the outer mast weldment as shown.
*Feed the cable all the way to the top of the outer mast.

Step 28

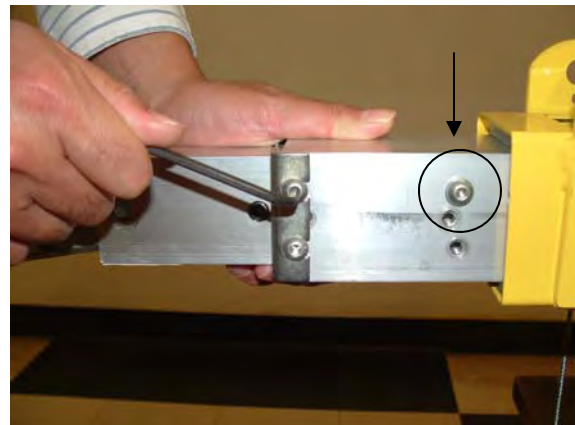

28. Locate (771044) screws, (773550) 1/4 lock washer, (784403) top covers and assemble them in both sides as shown.
*The lock washer goes on the single screw circled. This screw must be in the correct position for proper operation.

Step 29



29. Locate (772355) 3/8 lock nut, (771137) screw, (784394) 1/2" pulley spacers, (784390) 2-1/4" pulleys, (784446) 2" spacer and assemble has shown.

Step 30

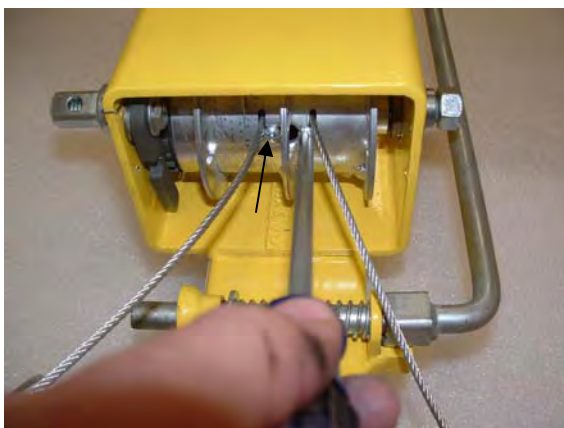

30. Insert cables in drum and secure with (776042) screws as shown. *Once cables are secure weave the excess cable on the drum.

Step 31



31. Locate (784408) pulley guard, (776042) screws and assemble as shown.

Step 32



32. Assemble (784428) winch cover and secure with (776042) screws.

Step 33



33. Assemble mast hold down assembly into the top mast and secure with (771055) screw and (772502) jam nut.

* Inspect and test unit after completion.