

SIDES	BOTTOM
4 PCS #1/4-28×1/2 Screws Installed	
Material:Steel-WELDING TUBE Galvanized	

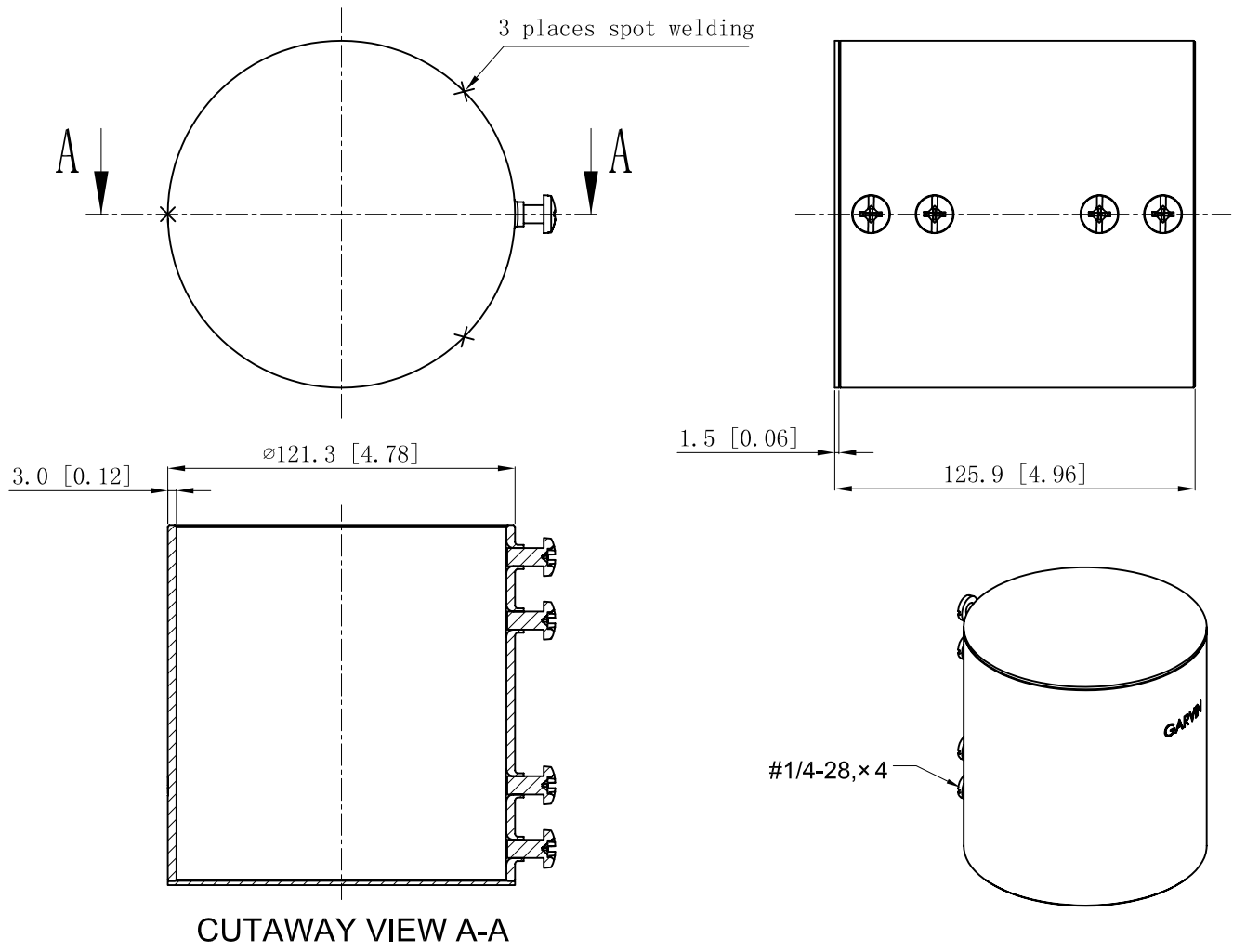

CUTAWAY VIEW A-A

This data sheet is for reference only .GARVIN INDUSTRIES reserves the right to make changes to the design without prior notice.

DESCRIPTION
TRADE REFERENCE TERMS

STANDARD PACKING
5 Pcs

GARVIN INDUSTRIES			
TITLE STEEL EMT SETREW COUPLINGS END CAPS TAMPERPROOF			
SIZE A4	DWG NO. CAPE400	REV A	
DATA SHEET			