



Southwire™

SURGE*GUARD

**LIMITED LIABILITY WARRANTY
WITH CONNECTED EQUIPMENT COVERAGE**



SOUTHWIRE.COM

COMPLETE POWER PROTECTION



YOUR RV IS AT THE MERCY OF THE POWER PEDESTAL!

Poor power quality entering your RV can not only affect the longevity of your electronic equipment and motors, but can cost you thousands of dollars in repairs and create frustrating, unnecessary travel delays. Surge protection in and around the home is commonplace in today's world. Surges, however, are not the only dangers to your electronic equipment. The quality of power entering a home is generally consistent; however, the same can not be said for RV parks. Power quality in RV parks is subject to vast fluctuations and is dependent upon many factors. Intensity of electrical loads placed on an RV park, weather conditions, faulty wiring, and undersized or deteriorating electrical connections affect the quality of power entering your RV. With today's RV containing sophisticated and sensitive electronics, a few short seconds of faulty power can damage equipment within the coach, such as inverters, converters, microwaves, TV's, and refrigerators.

SURGE GUARD* BUMPER TO BUMPER POWER PROTECTION

Southwire's Surge Guard* family of power protection devices are designed to protect your RV's electrical system and sophisticated electronics from the dangers of faulty electrical power. A variety of Surge Guard* products protect your RV from:

- High/Low voltage
- Miswired pedestals
- Open neutral
- Open ground
- Reverse polarity
- High neutral current
- Surges
- Overheating plug/receptacle

SURGE GUARD* RV POWER PROTECTION **DON'T PLUG IN WITHOUT IT!**



Surge Guard* power protection devices shut off power if the voltage drops below 102V or rises above 132V. Once the voltage resumes within these parameters, power is restored to the RV with a time delay to account for AC head pressure bleed off. Surge Guard* devices monitor for faulty wiring from the power pedestal and protects from reverse polarity and the dangers of open neutral and ground conditions. Patent-pending thermal protective plug/receptacles will shut off when overheating, reducing the risks of fire and damaged wires and plugs. Multi-mode surge protection eliminates the potential for power surges to enter the RV through power cables during electrical storms, and indicates when surge failure has occurred. Surge Guard* power protection is available in portable and hardwire configurations.

SURGE GUARD* **AUTOMATIC TRANSFER SWITCH FAMILY**

Surge Guard* Automatic Transfer Switches (ATS) also includes RVC compatible devices. The ATS models transfer to generator power automatically when energized. When both shore power and generator power are available, generator dominates after a 30 second delay. Once the generator is shut down, shore power activates. Automatic Transfer Switch models are available with maximum spike current from 26,400A – 130,000A, and surge suppression from 2600 Joules – 3350 Joules. Some ATS models offer optional remote displays.

THE VALUE OF SURGE GUARD* TECHNOLOGY

FROM PEDESTAL TO PANEL

Poor power quality entering your RV can not only effect the longevity of your electronic equipment and motors, but can cost you thousands of dollars in repairs and create frustrating, unnecessary travel delays. Electrical fires can lead to costly damage and/or complete loss of the RV, expensive insurance claims, and inconvenient downtime.

90%  **OF ALL RV'S**
DO NOT HAVE ANY FORM OF
ELECTRICAL PROTECTION.



PROTECT AGAINST THE DANGERS OF ELECTRICAL FIRES.

ELECTRICAL ISSUES DAMAGING RVs

POWER SURGES

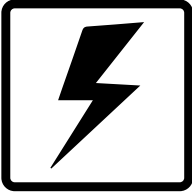

FIRE / DAMAGE TO RV
ELECTRONICS & APPLIANCES

OVERHEATING



MELTED WIRES AND PLUGS
ELECTRICAL FIRES

**OPEN GROUND/OPEN
NEUTRAL**



DANGEROUS / FATAL SHOCK
DAMAGE TO ELECTRONICS

**LOW / HIGH
VOLTAGE**



OVERHEATING CIRCUIT
BOARDS DAMAGE TO
ELECTRONICS/APPLIANCES

**MISWIRED
PEDESTAL**

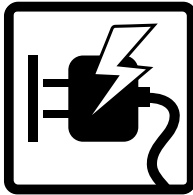

ELECTRICAL SHOCK / FIRE
DAMAGE TO ELECTRONICS



**WE HAVE
YOU COVERED**

SURGE GUARD* BASIC PORTABLE



MODEL 44750
WITH GROUND FAULT PROTECTION
120V, 30A
10/3 AWG CORD

PERFECT FOR POP-UPS AND TRAVEL TRAILERS

- Automatically shuts off the power when ground faults are present
- Requires manual reset after a ground fault
- Weather resistant
- Most economically priced protection
- 510 Joules of power surge protection
- 8mA trip level
- Easy-T-Pull™ handles
- Compatible with Surge Guard* Lock Hasp model 34590
- 2.10"W x 20.15"L x 2.10"D



SURGE GUARD* 30A & 50A SURGE PROTECTORS

MODEL 44260

120V, 30A
2100 JOULES



MODEL 44270

120/240V, 50A
4200 JOULES



PERFECT FOR POP-UPS AND TRAVEL TRAILERS

- Identifies faulty park power plus offers surge protection
- Analyzes circuits to verify pedestal wiring
- Indicators illuminate to show power status
- Tests for and indicates:
 - Open ground
 - Open neutral
 - Correct polarity
- Easy-T-Pull™ handles
- Compatible with Surge Guard* Lock Hasp model 34590
- **44260:** 2.4"W x 14.40"L x 1.85"D
- **44270:** 3.06"W x 15.86"L x 1.85"D

SURGE GUARD* 30A & 50A SURGE PROTECTORS WITH ENHANCED DIAGNOSTICS

MODELS 44280/44380

120V, 30A
2100 JOULES

MODELS 44290/44390

120/240V, 50A
4200 JOULES



PERFECT FOR POP-UPS AND TRAVEL TRAILERS

- Identifies faulty park power and provides surge protection
- Increased receptacle brass thickness reduces heat
- Easy-T-Pull™ handle with integrated receptacle
- Easy to read LED fault chart provides simple power analysis
- Includes anti-theft lock ring on cord
- Tests for and Indicates
 - Open neutral
 - Open ground
 - Reverse polarity
 - Open circuit/no power
 - Missing leg 1/leg 2 voltage *50A only*
 - Surge protection status
 - Overheating plug/receptacle
- UL/CUL Listed- Models **44380 & 44390**
- Fully enclosed receptacle cover- Models **44380 & 44390**
- **44280/44380**: 4.25"W x 15"L x 4.25"D
- **44290/44390**: 4.25"W x 17.5" L x 4.25"D

SURGE GUARD* 30A & 50A FULL PROTECTION PORTABLES

MODEL 34930

120V, 30A
2450 JOULES



MODEL 34950

120/240V, 50A
4200 JOULES



RV SIDE ELECTRICAL PROTECTION

Total electrical protection from faulty park power and electrical issues inside the RV.

PROVIDES PROTECTION AGAINST:

- Power surges
- Open ground
- Open neutral
- Low (<102V) / High (>132V) voltage
- Overheating plug/receptacle
 - Continuously monitors for and displays:
 - Voltage and Amp Draw (RMS)
- Includes anti-theft lock ring on cord
- Patent-pending RV side open neutral protection (50A only)
- Multi-mode surge suppression
- Commercial-grade, brass receptacle
- Automatic reset on power restoration
- 10 second start up sequence
- 128 second reset delay protects A/C compressor
- LCD display (English)
- Easy-T-Pull™ handles
- **34930:** 4.68"W x 21.50"L x 3.86"D
- **34950:** 4.68"W x 22.00"L x 3.86"D
- Reverse polarity
- Miswired pedestal
- High neutral current (50A model)
- Elevated ground line current

SURGE GUARD* 30A & 50A FULL PROTECTION PORTABLES WITH OPTIONAL WIRELESS COMMUNICATION



MODEL 34931

120V, 30A
2450 JOULES

MODEL 34951

120/240V, 50A
4200 JOULES



Optional



The Bluetooth® word mark and logos are registered trademarks of Bluetooth® SIG, Inc. and any use of such marks by Southwire Company, LLC is under license. Apple and the Apple logo are trademarks of Apple, Inc, registered in the U.S. and other countries. App Store is a service mark of Apple, Inc.

RV SIDE ELECTRICAL PROTECTION

Total electrical protection from faulty park power and electrical issues inside the RV.

PROVIDES PROTECTION AGAINST:

- Power surges
- Open ground
- Open neutral
- Low (<102V) / and High (>132V) voltage
- Continuously monitors for and displays:
 - Voltage and Amp Draw (RMS)
- Low and high frequency protection
- Includes anti-theft lock ring on cord
- Patent-pending RV side open neutral protection (50A only)
- Multi-mode surge suppression
- Commercial-grade, brass receptacle
- Automatic reset on power restoration
- 10 second start up sequence
- 128 second reset delay protects A/C compressor
- LCD display (English)
- Easy-T-Pull™ handles
- Compatible with 40301 Wireless LCD Display
- **34931:** 4.68"W x 21.50"L x 3.86"D
- **34951:** 4.68"W x 22.00"L x 3.86"D
- Overheating plug/receptacle
- Reverse polarity
- Miswired pedestal
- High neutral current (50A model)
- Elevated ground line current

SURGE GUARD* 30A & 50A FULL PROTECTION HARDWIRES

MODEL 35530

120V, 30A
2450 JOULES



Optional

MODEL 35550

120/240V, 50A
3850 JOULES

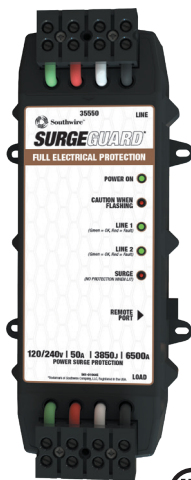

Optional



TOTAL ELECTRICAL PROTECTION FROM FAULTY PARK POWER.

PROVIDES PROTECTION AGAINST:

- Power surge
- Open ground
- Open neutral
- Low (<102V) / High (>132V) voltage
- Continuously monitors for and indicates:
 - Voltage and Amp Draw (RMS)
 - Surge failure
- Multi-mode surge suppression
- Automatic reset on power restoration
- 128 second reset delay protects A/C compressor
- LCD display (English)
- Optional remote power monitor LCD display (p/n 40300 sold separately)
 - Joystick for easy screen navigation
 - Plug and Play for telecom jack equipped models
- **35530:** 5.30"W x 11.12"L x 4.39"D
- **35550:** 5.30"W x 11.39"L x 4.93"D

BASIC 30A & 50A AUTOMATIC TRANSFER SWITCHES

MODEL 41300 120V, 30A, 60HZ



MODEL 40100 120/240V, 50A, 60HZ



Transfers to generator power automatically when energized after 30 second delay. When both shore power and generator power are available, generator dominates after a 30 second delay. Once the generator is shut down, shore power activates after a 3-4 second delay.

- 30A Model 41300 has proprietary electrical interlock
- 50A Model 40100 has mechanical interlocking contactors
- Time delay at power up
- Dual contactor arrangement
- Does NOT provide surge protection
- UL approved - UL1008 full transfer switch rating
- **41300:** 6.75"W x 7.62"L x 3.32"D
- **40100:** 8.25"W x 9.56"L x 5.25"D



SURGE GUARD* 50A AUTOMATIC TRANSFER SWITCH

MODEL 41260

WITH LIMITED RV POWER PROTECTION

120/240V, 50A, 60HZ

2600 JOULES



Transfers to generator power automatically when energized after 30 second delay (generator mode). When both shore and generator power are available, generator dominates after a 30 second delay. Once generator shuts down, shore power activates after 3 second delay.

- Limited protection from faulty park power
Provides protection against:
 - Power surges
 - Open neutral
 - Reverse polarity
- Multi-mode surge suppression
- 50A, FLA mechanical interlocking contactors
- UL approved – UL1008 full transfer switch rating
- 8.84"W x 13.5"L x 5.21"D

SURGE GUARD* 30A RVC AUTOMATIC TRANSFER SWITCH

MODEL 40430-RVC

RVC COMPATIBLE WITH FULL RV POWER PROTECTION

120V, 30A, 60HZ

2450 JOULES



Optional

Transfers to generator power automatically when energized after 30 second delay (generator mode). When both shore and generator power are available, generator dominates after 30 second delay. Once generator shuts down, shore power activates after a 3 second delay

- Total electrical protection from faulty park power
- Provides protection against:
 - Power surges
 - Open ground
 - Open neutral
 - Low (<102V) / High (>132V) voltage
 - Reverse polarity
 - Miswired pedestal
 - High / low frequency
- RVC communication allows instant display of voltage, current and fault conditions on RVC compatible device
- Indicator lights on front of ATS indicate Open Ground & Surge status
- Optional Remote Power Monitor LCD Display (P/N 40299 sold separately)
- Voltage and current (continuously monitored and indicated)
- Easy to navigate faults in plain English
- 40A FLA, Proprietary electrical interlock contactors
- UL approved – UL1008 full transfer switch rating
- 8.25"W x 9.56"L x 5.25"D

SURGE GUARD* 50A RVC AUTOMATIC TRANSFER SWITCH

MODEL 40350-RVC

RVC COMPATIBLE WITH FULL RV POWER PROTECTION

120/240V, 50A, 60HZ

3350 JOULES



Optional



Transfers to generator power automatically when energized after 30 second delay (generator mode). When both shore and generator power are available, generator dominates after a 30 second delay. Once generator shuts down, shore power activates after 3 second delay.

- Total electrical protection from faulty park power
- Provides protection against:
 - Power surges
 - Open ground
 - Open neutral
 - Low (<102V) / High (>132V) voltage
 - Reverse polarity
 - Miswired pedestal
 - High / low frequency
- Multi-mode surge suppression
- RVC communication allows instant display of voltage, current and fault conditions on an RVC compatible device
- Indicator lights on front of ATS indicate presence of input power for L1 and L2
- Optional Remote Power Monitor LCD Display (P/N 40299 sold separately)
- Voltage and current (continuously monitored and indicated)
- Easy to navigate faults in plain English
- 65A, FLA mechanical interlocking contactors
- UL approved – UL1008 full transfer switch rating
- 8.84"W x 13.5"L x 5.21"D

SURGE GUARD* 50A RVC **AUTOMATIC TRANSFER SWITCH** **WITH SHORE POWER SENSING**

MODEL 40450-RVC

RVC COMPATIBLE WITH FULL RV POWER PROTECTION
120/240V, 50A, 60HZ
3350 JOULES



Transfers to generator power automatically when energized after 30 second delay (generator mode). When both shore and generator power are available, generator dominates after a 30 second delay. Once generator shuts down, shore power activates after 3 second delay.

- Total electrical protection from faulty park power
- Provides protection against:
 - Power surges
 - Open ground
 - Open neutral
 - Low (<102V) / High (>132V) voltage
 - Reverse polarity
 - Miswired pedestal
 - High / low frequency
- RVC communication allows instant display of voltage, current and fault conditions on an RVC compatible device
- Indicator lights on front of ATS indicate presence of input power for L1 and L2
- Optional Remote Power Monitor LCD Display (P/N 40299 sold separately)
- Voltage and current (continuously monitored and indicated)
- Easy to navigate faults in plain English
- 65A, FLA mechanical interlocking contactors
- UL approved – UL1008 full transfer switch rating
- 8.84"W x 13.5"L x 5.21"D

SURGE GUARD* 90A RVC AUTOMATIC TRANSFER SWITCH

MODEL 41390-RVC

RVC COMPATIBLE WITH FULL RV POWER PROTECTION
120/240V, 90A, 60HZ
3350 JOULES



Optional

Transfers to generator power automatically when energized after 30 second delay (generator mode). When both shore and generator power are available, generator dominates after a 30 second delay. Once generator shuts down, shore power activates after 3 second delay.

- Total electrical protection from faulty park power
- Provides protection against:
 - Power surges
 - Open ground
 - Open neutral
 - Low (<102V) / High (>132V) voltage
 - Reverse polarity
 - Miswired pedestal
 - High / low frequency
- Multi-mode surge suppression
- RVC communication allows instant display of voltage, current, and fault conditions on an RVC compatible device
- Indicator lights on front of ATS indicate presence of input power for L1 and L2
- Optional Remote Power Monitor LCD Display (P/N 40299 sold separately)
- Voltage and current (continuously monitored and indicated)
- Easy to navigate faults in plain English
- 95A, FLA mechanical interlocking contactors
- UL approved – UL1008 full transfer switch rating
- 12.3"W x 19.12"L x 6.14"D
- Display: 4.75"W x 3.50"L x 1.50"D

SURGE GUARD* ACCESSORIES

SURGE GUARD* OVER-VOLTAGE ADAPTER MODEL 44300 120V, 15A



- Provides connected equipment with over-voltage and limited surge protection
- Will turn off power to the connected equipment when a voltage above 138V is detected
- Over-voltage conditions can occur from an open-neutral in outlet wiring or from switching heavy loads, such as an air-conditioner or washer and dryer, on and off

SURGE GUARD* GENERATOR NEUTRAL-GROUND BONDING PLUG MODEL 44400



Most portable generators have a floating neutral. Surge Guard* products will detect this as an open ground condition and not allow power to pass through. To solve this problem, insert the Surge Guard* Generator Neutral-Ground Bonding Plug into a 15A receptacle on the generator control panel. This will create a neutral-to-ground bond and the open ground condition should be resolved. Please check the owner's manual of the generator to ensure the generator was designed with a floating neutral.

SURGE GUARD* LOCK HASP MODEL 34590



Lock not included

- Designed to prevent unauthorized removal of your Surge Guard electrical protector from your RV
- Fits all portable Surge Guard* models and Surge Guard* Voltage Regulators
- Easily attaches to standard 30A & 50A plugs
- Not compatible with Surge Guard* models 44280, 44290, 34930, 34931, 34950, and 34951

UNASSEMBLED

From Surge Guard*
Power Protection Device

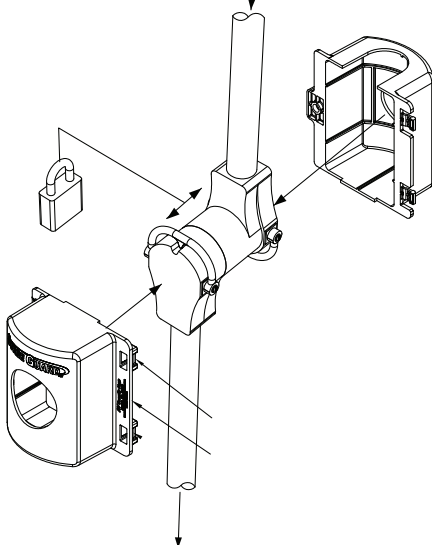

To RV Coach/Camper

ASSEMBLED

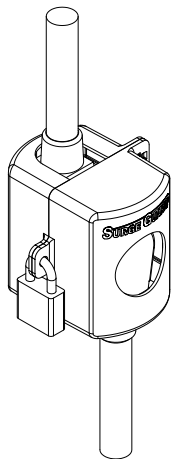

SURGE GUARD* ACCESSORIES

DIGITAL MONITOR MODEL AECM20020



- Fully tests incoming power for:
 - Open ground
 - Reverse polarity
 - High/Low voltage
- Three display modes available:
- Alternating voltage and frequency (VOLT/FREQ.)
 - Voltage only (VOLTAGE)
 - Frequency only (FREQUENCY)
- Accurate testing and monitoring of all AC power source types
- RMS voltage and frequency meter
- Multi-tone fault alarm
- Hands-free auto reset
- Advanced microelectronics
- One-button operation
- Wiring diagnostics
- LCD display with LED backlight
- UL listed





A MULTITUDE OF PROTECTION CHOICES FOR YOUR RV





SURGE GUARD* SURGE PROTECTOR COMPARE

SELECT THE LEVEL OF PROTECTION THAT YOUR RV NEEDS	30A Portable 34930	50A Portable 34930
		
Over Under Voltage (Input)	●	●
Open Neutral Protection (Input)	●	●
Open Ground Protection	●	●
Overheating Plug Receptacle Protection	●	●
Reverse Polarity Protection (Input)	●	●
Input & Output Open Neutral Protection	●	●
Surge Failure Indication	●	●
Miswired Pedestal Indication	●	●
Time Delay at Power Up	10 sec.	10 sec.
Compatible with Surge Guard iOS and Android apps.		
Optional Remote LCD Display		
Over Under Frequency Protection	●	●
Weather Resistant	●	●
UL Listed		
Source Power Connection Diagnostics	●	●
Lock Hasp Available		
Surge Suppression (Joules)	2,450	4,200
Max Spike Current (Per MOV)	6,500A	6,500A

COMPARE AUTOMATIC TRANSFER SWITCHES

AUTOMATIC TRANSFER SWITCHES COMPARISON

SELECT THE LEVEL OF PROTECTION YOUR RV NEEDS	BASIC	
	30A Basic ATS 41300	50A Basic 401
		
Over/Under Voltage (Input)		
Open Neutral Protection (Input)		
Reverse Polarity Protection (Input)		
Miswired Pedestal Indication		
Open Ground Protection		
Time Delay at Power Up (3-4 sec.)	●	●
Remote Display (P/N 40299)		
Current (Amps) Measurement		
Source Power Connection Diagnostics		
Generator Dominant	●	●
Mechanical Interlocking Contractors		●
Proprietary Electrical Interlock	●	
Surge Suppression (Joules)	N/A	N/A
Max Spike Current	N/A	N/A
Contractor Rating	30A, FLA	50A,
Safety Certified Standard	UL 1008	UL 1

	LIMITED	FULL PROTECTION		
ATS 00	50A Limited Protection 41260	50A Full Protection 40350-RVC	50A Full Protection 40450-RVC	90A Full Protection 41390-RVC
				
		●	●	●
	●	●	●	●
	●	●	●	●
		●	●	●
		●	●	●
●	●	●	●	●
		Optional	Optional	Optional
		●	●	●
		●	●	●
●	●	●	●	●
●	●	●	●	●
A	2,600	3,350	3,350	3,350
A	76,400A	130,000A	130,000A	130,000A
FLA	50A, FLA	65A, FLA	65A, FLA	95A, FLA
008	UL 1008	UL 1008	UL 1008	UL 1008

LIMITED LIFETIME WARRANTY AND CONNECTED EQUIPMENT COVERAGE

Select Surge Guard* products are covered under the Limited Lifetime and Connected Equipment Warranty. This warranty provides coverage for select Surge Guard* devices when properly installed according to Southwire's installation procedures, where defects in assembly, materials, or workmanship, caused it to operate outside of design specifications. Please keep in mind that each Surge Guard* model includes different features and protection capabilities, thus each claim question should be handled directly between the customer and Southwire Company, LLC. Any misuse, abuse, tampering, or modifications made to the products will void the warranty and opportunity to file a claim under the connected equipment policy. The Limited Lifetime Warranty does not cover the purchase of used, salvaged, or refurbished products.

PRODUCTS COVERED UNDER LIMITED LIFETIME WARRANTY

- 44260/44270 - Surge Protectors with Diagnostics
- 44280/44290 - Surge Protectors with Enhanced Diagnostics
- 44380/44390 - UL/CUL Surge Protectors
- 34930/34950 - Full Protection Portable
- 34931/34951 - Full Protection Portable
- 35530/35550 - Full Protection Hardwire
- 44300 - Over-voltage Adapter

WHAT IS CONNECTED EQUIPMENT COVERAGE?

The connected equipment portion of the Southwire Surge Guard* warranty will cover the repair/replacement of property that was damaged as a result of a warrantable failure of a Surge Guard* product. Since Surge Guard* products provide different levels of protection, what can qualify under this coverage will be dependent upon the Surge Guard* product being used. Depending on the individual claim, Southwire may request access to damaged equipment and site where damage occurred. Depending upon the claim, Southwire reserves the right to be subrogated under any existing insurance policies of the RV owner.

WARRANTY CLAIM PROCESS

Contact Southwire technical support directly at 1-800-780-4324 to start the return and evaluation process. Please do not return the Surge Guard* product in question to the dealer or retailer. Pending review and evaluation of the returned Surge Guard* product, at its discretion, Southwire will provide a new replacement Surge Guard* product of the same or a comparable model. Once an RMA number is issued, please ship the Surge Guard* device to:

Return Materials Department
Southwire Company, LLC
11211 69th St North
Largo, FL 33773

Claim processing requires proof of purchase with copy of original receipt with retail purchase date of November 27, 2017 or after to qualify under Southwire's Limited Lifetime and Connect Equipment Warranty.

WHERE TO FIND MORE INFORMATION?

For complete warranty information, please visit rvpower.southwire.com to view full warranty policy.



Southwire™

SURGE GUARD*

**LIMITED LIABILITY WARRANTY
WITH CONNECTED EQUIPMENT COVERAGE**

**SURGE GUARD* PRODUCTS
PROTECT YOUR RV AGAINST:**

POWER SURGES

OVER/UNDER VOLTAGE

MISWIRED PEDESTAL

OPEN NEUTRAL

OPEN GROUND

**OVERHEATING PLUG/RECEPTACLE
(PATENT-PENDING)**

**AVAILABLE IN 120V, 30A AND 120/240V,
50A PORTABLES AND HARDWIRES AND 120/240V,
50A AND 90A RVC COMPATIBLE
AUTOMATIC TRANSFER SWITCHES**

**LIMITED LIFETIME AND CONNECTED
EQUIPMENT WARRANTY**

Southwire Company, LLC.
11211 69th St North, Largo, FL 33773
rvpower.southwire.com • 800-780-4324

©2023 Southwire Company, LLC. All Rights Reserved.
®, ™, and * Trademark of Southwire Company, LLC.