



Southwire™

SURGE*GUARD

TRAINING MANUAL



PROTECT WHAT YOU VALUE MOST

SOUTHWIRE.COM

OUR STORY

As a family business, Southwire® proudly continues building on our commitment to environmental stewardship and corporate sustainability by prioritizing stakeholder expectations, and supporting the wellbeing of our communities and the environment in which we live. To help us meet this commitment, we organize our sustainability strategy around five core tenets: Growing Green, Living Well, Giving Back, Doing Right, and Building Worth.

We Deliver Power...Responsibly®

We remain committed to the sustainability of our company for the next 100 years and beyond. As we strengthen this commitment, we continue to work hard every day to discover, develop and distribute sustainable solutions that exceed the expectations of our stakeholders around the world.

OUR MISSION

To be a **preferred provider** of solutions to the electrical industry by providing innovative products and services with exceptional quality.

OUR VALUES

Our **ONE Southwire** culture prioritizes the interests of our team members, customers, and communities through a continuous commitment to empowerment, trust, consistency, and inclusion.

OUR REACH

Nearly one in two new homes built in the United States contains our wire, and we produce half of the cable used to transmit and distribute electricity throughout the nation.

OUR PRODUCTS

Our product teams and dedicated resources work together to listen to and work with our customers, creating solutions that deliver unparalleled value through product innovation, safety and efficiency.

OUR SERVICE

Service is more than a word or a phone number; it's a tangible support system that assists you through the entire project cycle; from our knowledgeable customer service team, to our experienced field sales team, we're there every step of the way.



TABLE OF CONTENTS

The Value of Surge Guard* Technology	4
Electrical Issues.....	5
Entry Level Portable Surge Protection.....	6-7
Full Feature Portable Surge Protection.....	8-9
Hardwired Full Feature Surge Protection	10
Comparative Feature Chart - Portables	12-13
Automatic Transfer Switches.....	14-16
Comparative Feature Chart - ATS	18-19
Surge Guard Accessories.....	20-21
Sales Tips and Guidelines.....	22-24
Frequently Asked Questions	25-26
Contact Information/Tech Support.....	27
Limited Lifetime & Connected Equipment Warranties	28-30

THE VALUE OF SURGE GUARD* TECHNOLOGY

WHY IS SURGE GUARD* RV POWER PROTECTION NEEDED

RVs hook up to power pedestals for shore power at campgrounds, parks and other locations. RVs today have highly sophisticated electronic circuitry with an array of expensive appliances ranging from air conditioners and microwaves to LCD/LED TVs. The single largest threat to an RV's electrical system and appliances is the "power pedestal", either miswired or faulty electrical power. Faulty power can result in significant damage to these appliances. Southwire manufactures a complete line of Surge Guard

products that offer bumper-to-bumper electrical system protection for all RVs.

Due to the enormous damage and repair expense caused by miswired pedestals and faulty power, many of the RV manufacturers have begun installing Surge Guard hardware models in their RVs. As RVs continue to increase in cost, so does the need to protect the investment. Surge Guard products are one of the best protection devices that an RV owner can purchase.



PROTECT AGAINST THE DANGERS OF ELECTRICAL FIRES.

WHAT IS SURGE PROTECTION

Surge protection is protection against voltage spikes or surges on power lines. These voltage spikes and surges can cause severe damage to electronic/electrical equipment, even if not in close proximity. Although several factors determine the effectiveness of surge protection, a loose guide is the number of joules rated for on the device. This should not be confused with over/

under voltage protection, which is effective for a gradual increase or decrease in voltage, exceeding the maximum or minimum voltage for which appliances are rated.

NOTE: Direct lightning strikes can be catastrophic. Although effectiveness varies, no device can guarantee protection against a close or direct lightning strike.

FROM PEDESTAL TO PANEL

Poor power quality entering your RV can not only effect the longevity of your electronic equipment and motors, but can cost you thousands of dollars in repairs and create frustrating, unnecessary travel delays. Electrical fires can lead to costly damage and/or complete loss of the RV, expensive insurance claims, and inconvenient downtime.

90%  **OF ALL RV'S**
DO NOT HAVE ANY FORM OF ELECTRICAL PROTECTION.

ELECTRICAL ISSUES DAMAGING RVS

POWER SURGES

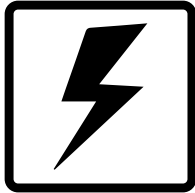

FIRE / DAMAGE TO RV ELECTRONICS & APPLIANCES

OVERHEATING



MELTED WIRES AND PLUGS ELECTRICAL FIRES

OPEN GROUND/OPEN NEUTRAL



DANGEROUS / FATAL SHOCK DAMAGE TO ELECTRONICS

LOW / HIGH VOLTAGE



OVERHEATING CIRCUIT BOARDS DAMAGE TO ELECTRONICS/APPLIANCES

MISWIRED PEDESTAL

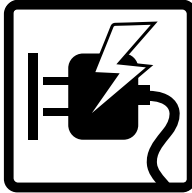

ELECTRICAL SHOCK / FIRE DAMAGE TO ELECTRONICS



WE HAVE YOU COVERED



ENTRY LEVEL PORTABLE SURGE PROTECTION

ENTRY LEVEL SURGE PROTECTION



BASIC PORTABLE WITH GROUND FAULT PROTECTION

44750 120V, 30Amp – 510 Joules of power surge protection

This product is the most economical and offers two types of electrical protection, surge suppression and ground fault protection. It does not protect against or identify miswired pedestals, low/high voltage, or open neutral conditions.

RV owners buy this product primarily to protect their RV's electronics from power surges. Rather than purchasing individual surge strips for individual circuits and appliances, this model protects the entire RV and its contents. It is perfect for tent campers, truck campers, and smaller travel trailers that have less amenities.

ENTRY LEVEL TRAVEL TRAILERS & POP-UPS



ENTRY LEVEL SURGE PROTECTION WITH INTELLIGENCE

44260 120V, 30Amp – 2100 Joules of power surge protection

44270 120/240V, 50Amp – 4200 Joules of power surge protection

Identifies faulty park power plus offers high grade surge protection. Plug into power pedestal to test for and indicate open ground, open neutral, or correct polarity. Indicators illuminate to show power and surge status. Models 44260 and 44270 provide diagnostics of the wiring conditions at the power pedestal. If the device shows an error, DO NOT plug in the RV.

This item is designed for the RVer who wants the wiring diagnostics not available with Model 44750, and high grade surge protection. This product provides surge protection only. It DOES NOT provide low/high voltage or miswiring protection.

44260
120V,
30 Amp

44270
120/240V,
50 Amp



ENTRY LEVEL PORTABLE SURGE PROTECTION

ENTRY LEVEL TRAVEL TRAILERS & POP-UPS



44280
120V,
30 Amp

44290
120/240V,
50 Amp

ENTRY LEVEL SURGE PROTECTION WITH ENHANCED INTELLIGENCE

44280 120V, 30Amp – 2100 Joules of power surge protection

44290 120/240V, 50Amp – 4200 Joules of power surge protection

44380 120, 30Amp – 2100 Joules of power surge protection

44390 120/240V, 50Amp – 4200 Joules of power surge protection

Identifies faulty park power plus offers industry leading surge protection. Plug into power pedestal to test for and indicate open ground, open neutral, or correct polarity. Indicators illuminate to show power status. Also includes a surge status and temperature sensor indicator LED. Models shown here provide diagnostics of the wiring conditions of the power pedestal. If the devices show an error, DO NOT plug in the RV.

These products are designed to provide additional wiring diagnostics along with a robust integrated receptacle. The receptacle structure allows for greater heat dissipation and includes an overheating sensor. Model 44380 and 44390 feature a fully enclosed receptacle.

These products provide surge protection only. They DO NOT provide low/high voltage or miswiring protection.



44380
120V,
30 Amp

44390
120/240V,
50 Amp



FULL FEATURE PORTABLE SURGE PROTECTION

FULL-FEATURED SURGE PROTECTION



34930
120V,
30 Amp

34950
120V/240V,
50 Amp

RV SIDE ELECTRICAL PROTECTION

34930 120V, 30Amp – 2450 Joules of power surge protection

34950 120V/240, 50Amp – 4200 Joules of power surge protection

PROVIDES PROTECTION AGAINST:

- Power surges
 - Open ground
 - Open neutral
 - Low (<102V) / and High (>132V) voltage
 - Overheating plug/receptacle
 - Reverse polarity
 - Miswired pedestal
 - High neutral current (50A model)
 - Elevated ground line current
- Includes anti-theft lock ring on cord
 - Patent-pending RV side open neutral protection (50A only)
 - Multi-mode surge suppression
 - Commercial-grade, brass receptacle
 - Automatic reset on power restoration
 - 10 second start up sequence
 - 128 second reset delay protects A/C compressor
 - LCD display (English)
 - Easy-T-Pull™ handles



FULL FEATURE PORTABLE SURGE PROTECTION



34931
120V,
30 Amp

34951
120/240V,
50 Amp



WORKS WITH SURGE GUARD
IOS AND ANDROID APPS



40301

RV SIDE ELECTRICAL PROTECTION



34931 120V, 30Amp - 2450 Joules of surge protection

34951 120/240V, 50Amp - 4200 Joules of surge protection

TOTAL ELECTRICAL PROTECTION FROM FAULTY PARK POWER AND ELECTRICAL ISSUES INSIDE THE RV.

PROVIDES PROTECTION AGAINST:

- Power surges
- Open ground
- Open neutral
- Low (<102V) / and High (>132V) voltage
- Overheating plug/receptacle
- Reverse polarity
- Miswired pedestal
- High neutral current (50A model)
- Elevated ground line current
- Continuously monitors for and displays:
 - Voltage and Amp Draw (RMS)
 - Low and high frequency protection
 - Includes anti-theft lock ring on cord
 - Patent-pending RV side open neutral protection (50A only)
 - Multi-mode surge suppression
 - Commercial-grade, brass receptacle
 - Automatic reset on power restoration
 - 10 second start up sequence
 - 128 second reset delay protects A/C compressor
 - LCD display (English)
 - Easy-T-Pull™ handles
 - Compatible with 40301 Wireless LCD Display
 - Compatible with Surge Guard iOS and Android apps.



SCAN FOR SURGE
GUARD* APP

WIRELESS LCD DISPLAY (optional)

40301 Compatible with Surge Guard Models 34931/34951

- Automatically detects 30A and 50A Surge Guard* units
- Provides detailed information regarding:
 - Voltage
 - Amp draw
 - Frequency
 - Kilowatt usage
 - Current fault screen
 - Fault log of previous 4 faults
 - Connection status
 - Visual alert of fault
 - Range of 100'
 - Includes optional mounting bracket
 - Operates on 3-AAA batteries

HARDWIRED FULL FEATURE SURGE PROTECTION

BUILT-IN PROTECTION



35530
120V,
30 Amp

Optional Remote
Monitor (P/N
40300) shown)



35550
120/240V,
50 Amp

Optional Remote
Monitor (P/N
40300) shown)

HARDWIRED PROTECTION

35530 120V, 30Amp – 2450 Joules of power surge protection

35550 120/240V, 50Amp – 3850 Joules of power surge protection

These hardwire units are permanently installed in the RV. They protect when the power pedestal is miswired or faulty power is detected.

When safe current is available to the RV, the “Power On” light will be illuminated. The “Line Voltage” light on the 30Amp model and both “Line Voltage #1 & #2” lights on the 50 Amp model will be illuminated to indicate that the circuits are operational.

One of the most common power pedestal problems that RVers experience is “low voltage”. When the voltage from the power pedestal drops below 102V or goes above 132V for more than 8 seconds or, in cases of instantaneous severe voltage drops or spikes, the power is automatically shut off. The Surge Guard* hardwire will automatically reset once the power problem has been corrected. There is a 128 second delay built in to protect the air conditioner compressor.

When the power issues are detected due to polarity, miswiring, or current-to-ground conditions, the “Caution Light” will illuminate to help the RV owner identify the cause of the power outage.



REMOTE POWER MONITOR LCD DISPLAY (optional)

40300 (Compatible with hardwire models 35530/35550)

When connected to Surge Guard* hardwired devices, this optional plug and play LCD Display, with 16 information fault screens, provides additional detailed information regarding incoming line voltages, current being used, and fault conditions. Connects to an RJ12 (6 pin) connector cable (included).









COMPARATIVE FEATURE CHART - PORTABLES







FEATURE COMPARISON CHARTS

FIND THE RIGHT LEVEL OF PROTECTION WITH THIS QUICK-REFERENCE FEATURE GUIDE.

SURGE GUARD* SURGE PROTECTOR COMPARISON

SELECT THE LEVEL OF PROTECTION THAT YOUR RV NEEDS	SURGE		SURGE+			
	30A Portable 44260	50A Portable 44270	30A Portable 44280	50A Portable 44290	30A Portable 44380	50A Portable 44390
						
Over Under Voltage (Input)						
Open Neutral Protection (Input)						
Open Ground Protection						
Overheating Plug Receptacle Protection			Indicates	Indicates	Indicates	Indicates
Reverse Polarity Protection (Input)						
Elevated Ground Protection						
Surge Failure Indication	●	●	●	●	●	●
Miswired Pedestal Indication	●	●	●	●	●	●
Time Delay at Power Up						
Optional Remote LCD Display						
Over Under Frequency Protection						
Weather Resistant	●	●	●	●	●	●
UL Listed					●	●
Source Power Connection Diagnostics	●	●	●	●	●	●
Lock Hasp Available	●	●				
Surge Suppression (Joules)	2,100	4,200	2,100	4,200	2,100	4,200
Max Spike Current (Per MOV)	6,500A	6,500A	6,500A	6,500A	6,500A	6,500A

COMPARATIVE FEATURE CHART - PORTABLES

SELECT THE LEVEL OF PROTECTION THAT YOUR RV NEEDS	FULL PROTECTION					
	30A Portable 34930	50A Portable 34950	30A Portable 34931	50A Portable 34951	30A Portable 35530	50A Portable 35550
						
Over Under Voltage (Input)	●	●	●	●	●	●
Open Neutral Protection (Input)	●	●	●	●	●	●
Open Ground Protection	●	●	●	●	●	●
Overheating Plug Receptacle Protection	●	●	●	●		
Reverse Polarity Protection (Input)	●	●	●	●	●	●
Input & Output Open Neutral Protection	●	●	●	●		
Surge Failure Indication	●	●	●	●	●	●
Miswired Pedestal Indication	●	●	●	●	●	●
Time Delay at Power Up	10 sec.	10 sec.	10 sec.	10 sec.	128 sec.	128 sec.
Compatible with Surge Guard iOS and Android apps.			●	●		
Optional Remote LCD Display			40301	40301	40300	40300
Over Under Frequency Protection	●	●	●	●		
Weather Resistant	●	●	●	●		
UL Listed					●	●
Source Power Connection Diagnostics	●	●	●	●	●	●
Lock Hasp Available						
Surge Suppression (Joules)	2,450	4,200	2,450	4,200	2,450	3,850
Max Spike Current (Per MOV)	6,500A	6,500A	6,500A	6,500A	6,500A	6,500A

AUTOMATIC TRANSFER SWITCHES

AUTOMATIC TRANSFER SWITCHES

BASIC TRANSFER SWITCHES

41300 120V, 30Amp, 60Hz – Electrical interlocking contactors

40100 120/240V, 50Amp, 60Hz – Mechanical interlocking contactors

The basic Automatic Transfer Switch transfers to generator power automatically when energized after a 30 second delay. When both shore power and generator power are available, generator dominates after a 30 second delay. Once the generator is shut down, shore power activates after a 3-4 second delay.

Conforms to requirements of UL 1008.

***Does NOT provide surge protection**



TRANSFER SWITCH WITH LIMITED RV POWER PROTECTION

41261 120/240V, 50Amp, 60Hz – Mechanical interlocking contactors

This unit transfers to either shore power or generator power automatically when energized. In the event both shore and generator powers are available, generator power will dominate after a 30 second delay. Provides Low and High Voltage Protection, open neutral, open ground, and reverse polarity protection, as well as 2,600 joules of multi-mode power surge suppression.

Used by the top OEMs on many fifth wheel and motorhome product lines.



RVC COMPATIBLE AUTOMATIC TRANSFER SWITCH

40430-RVC 120V, 30Amp, 60Hz - Full RV power protection

40350-RVC 120/240V, 50Amp, 60Hz – Full RV power protection

40450-RVC 120/240V, 50Amp, 60Hz – Full RV power protection

Multi-mode surge suppression (fuse protected) and protects against low/excessive voltage (<95V/>132V), miswired pedestal, open neutral, open ground, high/low frequency, and reverse polarity.

Transfers to generator power automatically when energized after a 30 second delay. When both shore power and generator power are available, generator dominates after a 30 second delay. Once the generator is shut down, the shore power activates after a 3-4 second delay. Oversize contactors and UL Approved ATS - full transfer switch rating. Used by the top OEMs on high end fifth wheel and motorhome product lines.



AUTOMATIC TRANSFER SWITCH WITH REVERSE POLARITY AND OPEN GROUND PROTECTION

41301 120v, 30a, 60Hz - Electrical Interlocking Contractors

This unit transfers to either shore power or generator power automatically when energized. In the event both shore and generator powers are available, generator power will dominate after a 30 second delay. Provides open ground and reverse polarity protection.



AUTOMATIC TRANSFER SWITCH WITH REVERSE POLARITY AND OPEN GROUND PROTECTION

40141 120/240V, 50Amp, 60Hz - Mechanical Interlocking Contractors

This unit transfers to either shore power or generator power automatically when energized. In the event both shore and generator powers are available, generator power will dominate after a 30 second delay. Provides open ground and reverse polarity protection.



AUTOMATIC TRANSFER SWITCH WITH REVERSE POLARITY AND OPEN GROUND PROTECTION

40101 120v/240V 50Amp, 60Hz - Mechanical Interlocking Contractors

This unit transfers to either shore power or generator power automatically when energized. In the event both shore and generator powers are available, generator power will dominate after a 30 second delay. Provides open ground and reverse polarity protection.



AUTOMATIC TRANSFER SWITCHES

AUTOMATIC TRANSFER SWITCHES

90A RVC COMPATIBLE AUTOMATIC TRANSFER SWITCH

41390-RVC 120/240V, 90Amp, 60Hz – Full RV power protection

Multi-mode surge suppression (fuse protected) and protects against low/excessive voltage (<95V/>132V), miswired pedestal, open neutral, open ground, high/low frequency, and reverse polarity.

Transfers to generator power automatically when energized after a 30 second delay. When both shore power and generator power are available, generator dominates after a 30 second delay. Once the generator is shut down, the shore power activates after a 3-4 second delay. Oversize contactors and UL Approved ATS - full transfer switch rating.



RVC COMPATIBLE REMOTE POWER MONITOR LCD DISPLAY

(optional)

40299 (Compatible with ATS models 40350/41390)

When connected to the above Surge Guard* RVC compatible automatic transfer switches, the optional plug and play LCD Display, with 16 information fault screens, shows more detailed information regarding incoming line voltages, current being used, and fault conditions. Connects to an RJ12 (6 pin) connector cable (not included).











COMPARATIVE FEATURE CHART - ATS





FEATURE COMPARISON CHARTS

FIND THE RIGHT LEVEL OF PROTECTION WITH THIS QUICK-REFERENCE FEATURE GUIDE.

AUTOMATIC TRANSFER SWITCHES COMPARISON

SELECT THE LEVEL OF PROTECTION YOUR RV NEEDS	BASIC		LIMITED			
	30A Basic ATS 41300	50A Basic ATS 40100	30A ATS 41301	50A ATS 40141	50A ATS 40101	50A Limited Protection 41261
						
Over/Under Voltage (Input)						●
Open Neutral Protection (Input)						●
Reverse Polarity Protection (Input)			●	●	●	●
Miswired Pedestal Indication			●	●	●	●
Open Ground Protection			●	●	●	●
Time Delay at Power Up (3-4 sec.)	●	●	●	●	●	●
Remote Display (P/N 40299)						
Current (Amps) Measurement						
Source Power Connection Diagnostics						
Generator Dominant	●	●	●	●	●	●
Mechanical Interlocking Contactors		●		●	●	●
Proprietary Electrical Interlock	●		●			
Surge Suppression (Joules)	N/A	N/A				2,600
Max Spike Current	N/A	N/A				76,400A
Contactor Rating	30A, FLA	50A, FLA	40A, FLA	50A, Resistive	50A, FLA	50A, FLA
Safety Certified Standard	UL 1008	UL 1008	UL 1008	UL 1008	UL 1008	UL 1008

COMPARATIVE FEATURE CHART - ATS

SELECT THE LEVEL OF PROTECTION YOUR RV NEEDS	FULL PROTECTION			
	30A RVS Compatible ATS 40430	50A Full Protection 40350-RVC	50A Full Protection 40450-RVC	90A Full Protection 41390-RVC
				
Over/Under Voltage (Input)	●	●	●	●
Open Neutral Protection (Input)	●	●	●	●
Reverse Polarity Protection (Input)	●	●	●	●
Miswired Pedestal Indication	●	●	●	●
Open Ground Protection	●	●	●	●
Time Delay at Power Up (3-4 sec.)	●	●	●	●
Remote Display (P/N 40299)	Optional	Optional	Optional	Optional
Current (Amps) Measurement	●	●	●	●
Source Power Connection Diagnostics	●	●	●	●
Generator Dominant	●	●	●	●
Mechanical Interlocking Contactors		●	●	●
Proprietary Electrical Interlock	●			
Surge Suppression (Joules)	2,450	3,350	3,350	3,350
Max Spike Current	67,000A	130,000A	130,000A	130,000A
Contactor Rating	40A, FLA	65A, FLA	65A, FLA	95A, FLA
Safety Certified Standard	UL 1008	UL 1008	UL 1008	UL 1008

SURGE GUARD ACCESSORIES

SURGE GUARD* ACCESSORIES

SURGE GUARD* OVER-VOLTAGE ADAPTER

Model 44300 120V, 15A, 314 Joules

- Provides connected equipment with over-voltage and limited surge protection
- Will turn off power to the connected equipment when a voltage above 140V is detected
- Over-voltage conditions can occur from an open-neutral in outlet wiring or from switching heavy loads, such as an air-conditioner or washer and dryer, on and off



SURGE GUARD* GENERATOR NEUTRAL-GROUND BONDING PLUG

Model 44400

Most portable generators have a floating neutral. Surge Guard* power protection devices will detect this as an open ground condition and not allow power to pass through. To solve this problem, insert the Surge Guard Generator Neutral-Ground Bonding Plug into a 15A receptacle on the generator control panel. This will create a neutral to ground bond and the open ground condition should be resolved. Please check the owner's manual of the generator to ensure the generator was designed with a floating neutral.



UNIVERSAL LOCK HASP

34590 Lock Hasp (padlock not included)

Fits most portable Surge Guard* models and Surge Guard Voltage Regulators, as well as standard 30Amp and 50Amp portable plugs. Not compliant with Surge Guard models 44280, 44290, 34930, and 34950.

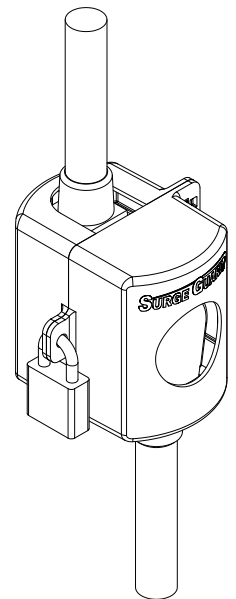
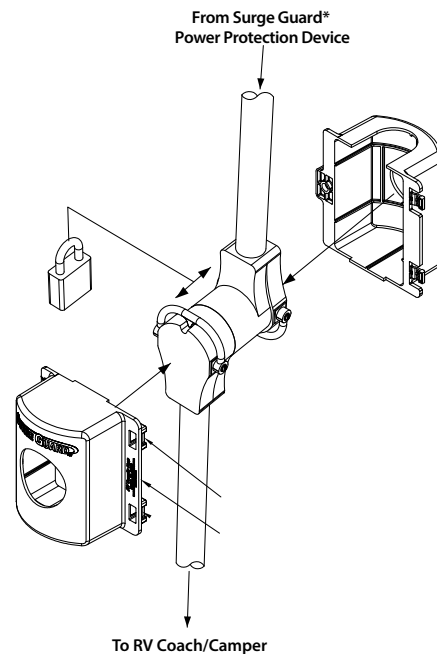

UNASSEMBLED

ASSEMBLED

DIGITAL POWER MONITOR

AECM20020 Digital Power Monitor

This microelectronics power monitor and diagnostics tool is one of the most advanced on the market. Plug into any 15Amp outlet and the backlit LCD display shows RMS voltage and frequency. The mode button allows for the voltage, frequency, or both to be displayed alternately.

If a fault is encountered, the display screen will display one of the following:

- LO (Low Voltage < 102V)
- HI (High Voltage > 135V)
- LF (Low Frequency < 55Hz)
- HF (High Frequency > 65Hz)
- GF (Ground Fault)
- PF (Polarity Fault)

If the fault continues for more than 3 seconds, a 5 second audible alarm sounds.

This power monitor features an audible alarm, RMS technology (reads inverters and generators correctly), and digitally displays all faults with built in surge suppression.



SOUTHWIRE RV TOOL KIT

EM-KIT Electrical Maintenance Kit

With Southwire's RV Tool Kit, you will be prepared for any bumps in the road. From loose connections to a dark campsite, our RV Tool Kit has you covered. Southwire's RV Tool Kit is vital to perform basic electrical testing in addition to providing tools for maintenance and quick repairs, allowing you more time to enjoy the great outdoors.



SURGE GUARD* RV POWER PROTECTION PRODUCTS SALES TIPS

The following sales tips incorporate proven successful techniques that we have used at retail shows, dealerships, parts and service department sales, and new coach sales walk-throughs. These tips are beneficial at any time for promoting Southwire Surge Guard power protection.

- PEOPLE MAKE DECISIONS EMOTIONALLY
- PEOPLE JUSTIFY DECISIONS WITH FACTS
- PEOPLE LOOK FOR VALUE
- PEOPLE WANT THEIR NEEDS MET

- KNOW THE PRODUCT, SPECIFICATIONS, MODELS AND ACCESSORIES
- MAKE SURGE GUARD PRODUCTS PART OF EVERY COACH SALE WALK-THROUGH
- DURING PRESENTATION, TRY TO ANSWER ALL QUESTIONS BEFORE THEY ARE ASKED
- USE ANALOGIES CONSUMERS CAN UNDERSTAND

"I'm sure you or a family member has a computer, HD TV, or other electronic item at home protected with an electrical surge strip. If you are willing to protect a \$400-\$1200 appliance at your residence that is designed to have a stable power supply, why would you not want to protect your new coach investment at RV sites that are notorious for having unstable and inconsistent voltage and power sources?"

"I'm sure you're familiar with how a dam and spillway work. When the water level gets too high, the spillway releases the excess water to prevent flooding over the dam. A surge protector operates in a similar matter. When excess current is present, the surge protector is designed with a series of 'spillways' that take the excess current and dissipate it until it is at a level that is acceptable for use."

According to a study conducted by No Shock Zone in 2010, 21% of RV owners that responded to the survey indicated that they have been shocked by their RV. This is known as "Hot Skin" and can be prevented by Surge Guard RV power protection portable and hardwire products. Hot skin occurs due to a damaged or missing grounding path for the RV. Either through a damaged pedestal or damaged wiring, this can lead to a small shock or possibly electrocution."

THERE ARE A MULTITUDE OF DANGERS AT RV CAMPGROUNDS

Miswired Pedestals: Such as no neutral, no ground, reverse polarity. These can cause immediate damage to many or all of your 120V appliances and/or cause personal injury.

Damaged Pedestals: Damaged receptacles and wiring can occur through any number of situations. Most people have seen another camper drive off while still plugged in. This can damage everything from the plug to the internal wiring of the pedestal, leading to a potentially harmful power source.

Low or High Voltage: 120V appliances operating ranges are 102V to 136V. Operating appliances below or above this operating voltage will cause heat buildup. (Visualize all appliance motors, circuit boards, and appliance electronics heating up like the inside of your toaster). Voltage below 102V or above 136V will cause appliance degradation damage, while voltages below 95V or above 140V can cause immediate damage.

Power Surges: Everyone can usually relate surges to storms but, in reality, surges can be caused by other external sources such as black outs, power or industrial plants powering on or off, and even within the RV park by power inconsistency.

Overheating Plug/Receptacle: Electrical fires can occur as a result of the overheating and melting of plugs and receptacles. Protect against loss by electrical fires with the patent-pending thermal over-temperature sensor technology.

NA FAILURE OF JUST ONE CIRCUIT BOARD CAN COST A CONSUMER \$400+, WHICH MAY OR MAY NOT BE COVERED BY INSURANCE.

Even if it is covered, the out-of-pocket deductible can be \$500-\$1000. (Deductible and potential RV repair down time are two important items to discuss during the presentation.)

SURGE GUARD FULL PROTECTION MODELS ARE AVAILABLE IN PORTABLE AND HARDWIRE VERSIONS FOR BOTH 30AMP AND 50AMP HOOK UP.

These models will not only protect the coach from voltage surges, they automatically test pedestal wiring and voltage and WILL NOT allow power to the coach if there are any electrical issues. Should you have low voltage or high voltage conditions, the unit will automatically cut power to protect the coach, and automatically return electrical service when safe power returns. The full protection Surge Guard models also incorporate a time delay to prevent short cycling and protect the coach's A/C system. These Surge Guard models will self-sacrifice to save the coach should the RVer accidentally plug into an incorrect power source (240V) or a surge exceeds its protection rating.

WHAT DOES JOULE REALLY MEAN?

There are components inside every surge protector called MOVs (metal oxide varistors). These components are the key to surge protection. The joule rating of the device is a key point in determining the capability of the surge protector. When a surge or spike is present, the MOVs will clamp and dissipate the excess current through both heat and diverting current back through the ground, thus

preventing the excess current from reaching the RV. A simple and easy to understand comparison is joules are like calories. When active, the human body heats up and burns off calories from excess energy. Just like calories, joules are the amount of energy that a surge protector can "burn off". A joule is the amount of energy that is dissipated over the given amount of time the surge is present. A joule is 1 watt per second.

WHY TAKE THE GAMBLE?

For the cost of replacing just one circuit board you can protect your expensive RV investment with Surge Guard RV power protection products.

HOW TO SELL FULL PROTECTION INSTEAD OF SURGE PROTECTION.

Start the sales and education process with the full protection product line and explain to the customer the need for a product that will disconnect power to protect their RV. While surges do occur, their RV will likely encounter voltage and wiring issues more often than a surge. The best way to protect their investment is to use a full electrical protection product. If the customer still does not want to spend the money, it is much easier to then sell them on a surge protector at that point.

MOST EFFECTIVE WAY FOR DEALERS TO SELL SURGE GUARD* PRODUCTS.

The dealers that have the most success selling Surge Guard* products utilize a demo Surge Guard unit in their PDI/walk-through process. This strategy has pushed dealers to sell a Surge Guard unit on average with 3 out of 4 RVs the dealership sells. The walk-through person is viewed as the expert by the customer and he or she is educating the buyer on how to operate and take care of their newly purchased RV. Take advantage of this educational opportunity and emphasize the need for electrical protection for RVs by discussing the unreliability of campground power.

SURGE GUARD* RV POWER PROTECTION PRODUCTS SALES TIPS

WHY IS LOW VOLTAGE COMMON IN CAMPGROUNDS?

Often, RV owners have a difficult time understanding why they need to protect their RV from voltage swings, because they very rarely encounter voltage issues at their home. To understand this, a comparison is needed on how much power is available to consume in a residential neighborhood versus the power available at a campground.

Demand factor is a calculation that power companies use to help determine the resources needed and the amount of power transformers and substations will need to provide to a specific area. When looking at campgrounds, more campsites means less available power. As more and more RVs come standard with 50A service, the strain on campgrounds' electrical systems and available power continues to increase.

To understand voltage and amperage, consider this water pressure analogy. You install sprinklers in your front and back yard. The sprinkler in the front yard is set to spray water to the sidewalk, but when you turn on the sprinkler in your back yard, the water from the sprinkler in the front is no longer reaching the sidewalk. A higher volume of water is required to run both sprinklers, which decreases the amount of water pressure available. Voltage and amperage can be understood similarly. In our example, water pressure represents voltage and water volume represents amperage. As amp draw increases (water volume) the available voltage decreases (water pressure).

This often occurs when RVers come back to their RV in the afternoon/evening and all of the air conditioners are turned on and appliances are being used to cook dinner. When this happens, there is a tremendous amount of amp draw demanded from the campground's electrical system. Usually, the first RV in the electrical run will have good voltage, but the RVs further down the line will progressively have lower voltage available. The first RV may receive 130V, while the last RV may only receive 95V.

WHAT IS DEMAND FACTOR?

$$f \text{ DEMAND } (t) = \frac{\text{DEMAND}}{\text{MAXIMUM POSSIBLE DEMAND}}$$

Calculation based upon expected demand compared to maximum demand

NEC TABLE 551.73

NUMBER OF RECREATIONAL VEHICLE SITES	DEMAND FACTOR (PERCENT)
1	100
2	90
3	80
4	75
5	65
6	60
7-9	55
10-12	50
13-15	48
16-18	47
19-21	45
22-24	43
25-35	42
36 plus	41

FREQUENTLY ASKED QUESTIONS

- **What does Surge Guard* model 34951 protect against?**

Surge Guard model 34950 detects and protects against a break in the neutral connection on the main neutral line from the output of the Surge Guard device to the connection at the main breaker panel.

- **Why is the patent-pending RV side open neutral protection important?**

The Surge Guard* model 34950 includes a patent-pending technology that allows for the detection of an open neutral condition inside of the RV. Until now, electrical protection was only available to detect and protect from open neutral conditions at the power pedestal.

- **What can cause an open neutral inside of an RV?**

- Loose/improper connection between shore power cord and inlet on RV
- Loose neutral connection in junction box
- Loose neutral connection of neutral conductor to main breaker panel
- Loose neutral connection in transfer switch
- Damaged/defective power cord reel
- Damaged/defective power cord
- Damaged neutral conductor inside of RV

- **What happens when an open neutral occurs in the 50A RV electrical system?**

Open neutral conditions in a 120/240V 50A electrical system are catastrophic because of the shared neutral line between Leg 1 and Leg 2. When the neutral line is lost, the split 120V system changes to a 240V loop. One of the legs will swing to extremely high voltage while the second leg will swing to extremely low voltage. This swing will quickly cause damage to all 120V equipment plugged in to outlets inside the RV. This can lead to high repair and replacement costs.

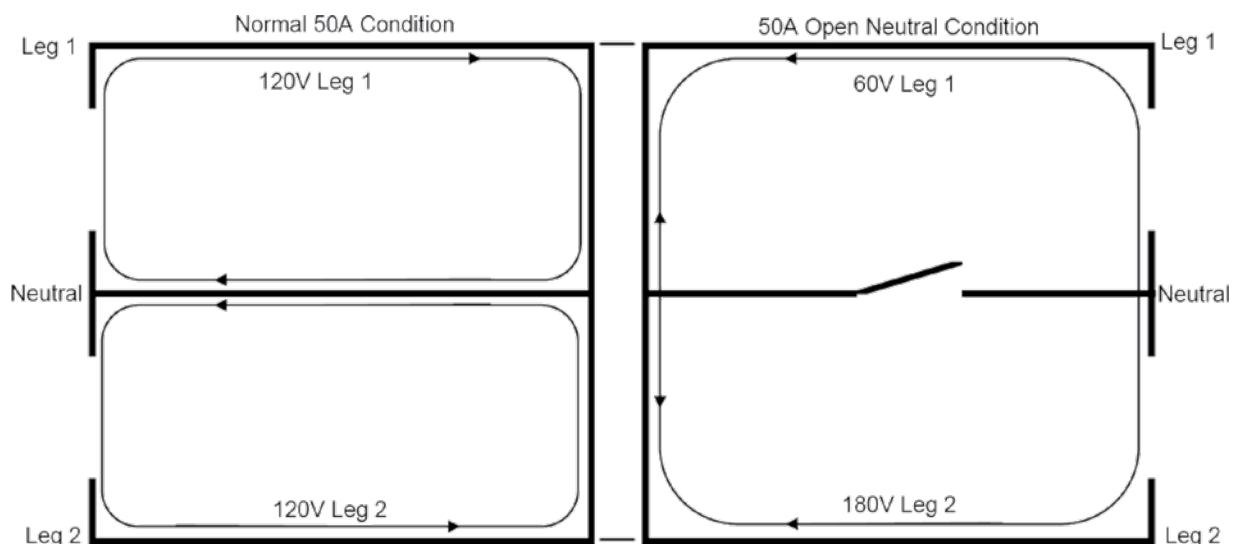

FREQUENTLY ASKED QUESTIONS

- **Can RVers use a 50Amp/30Amp adapter plug with their 50Amp Surge Guard® surge protector and hook up to a 30Amp power pedestal?**

Yes; however, their RV is wired with two 50Amp/120V circuits for a total of 100Amps while the 30Amp power pedestal will only provide a total of 30Amps of power. Subsequently, only a limited number of appliances can be operated without causing circuit breakers on the power pedestal to be thrown. The Surge Guard surge protector will provide the protection; however, the RVer may experience inconvenience due to the limited power.

- **Can I hook up a 30Amp Surge Guard surge protector to a 120V/50Amp power pedestal using a 30Amp/50Amp adapter?**

Yes, however, it is not recommended. The higher 50Amp input can cause the circuit breakers to be thrown.

- **Can an RV owner use a 'voltage boosting' product in conjunction with a Surge Guard surge protector?**

Yes, by plugging the voltage booster into the power pedestal in front of the Surge Guard device. The voltage booster's primary function is to increase the voltage in low voltage situations. The Voltage Regulator is not a protective device and the connected RV will not be protected from damage should an open neutral or surge develop during the course of operation. The fault indicator panel is for indication only. If the voltage booster is mounted after the Surge Guard device, the Surge Guard device will automatically shut off the power if it is below 102V for more than 8 seconds; subsequently not allowing the voltage booster to operate.

- **What is over voltage and under voltage protection?**

When over voltage or under voltage conditions occur, the Surge Guard device will shut the power off to the RV. This predetermined value is selected as the point beyond which electrical and electronic equipment is likely to be damaged if operated for an extended length of time. The user of any protective device is urged to be aware that protective devices are not necessarily effective for all circumstances. Bypassing for this condition can result in damage of electrical equipment on the coach.

- **How do I know my surge protection still works?**

Current Surge Guard models contain surge status LED lights. Please utilize the indicator lights to determine if surge protection is still active.

- **What does the term "Weather Resistant" mean?**

The term "Weather Resistant", sometimes described as "Rainproof", is used to describe many electrical products that are manufactured for outdoor use. Surge Guard products described as "Weather Resistant" can be used in most outdoor environments. Please note that these products should not be submerged under water at any time.

- **Doesn't the breaker panel in my RV provide electrical protection?**

Just like in a house, the breaker panel in the RV is only designed to interrupt power if the amperage load exceeds the circuit rating. This does not provide any protection related to voltage changes or any sort of input wiring issues.

FAQ & CONTACT INFORMATION/TECH SUPPORT

- **What product is Surge Guard* Lock Hasp compatible with?**

The Surge Guard lock hasp, model 34590, will only work on Surge Guard products with a corded receptacle. Surge Guard models 44750, 44260, 44270, 34830, 34850, 34730, 34750, and all previous generations of Surge Guard devices are compatible with the Surge Guard lock hasp model 34590. This device will also work with the Surge Guard voltage regulators, models 10176 and 10175.

- **What is the significance of the Joule rating?**

The Joule rating of a surge protection device is the ability of the product to absorb and dissipate a surge before the components are damaged and the ability to protect from a surge is ineffective. The higher the Joule rating of the device, the better the surge protection is.

- **What is generator dominant on transfer switches?**

The phrase “Generator Dominant” means the transfer switch will change the power source to the generator when the generator is running and shore power is available. In order to change back to shore power when both sources are available, the generator must be turned off.

- **Can Surge Guard devices be used with the automatic transfer switch models 41260 and 40350?**

Yes, Surge Guard portable and hardwire devices can be used in conjunction with Automatic Transfer Switch models 41260 and 40350. There will not be compatibility or performance issues with either product when they are used together.

- **Can a power strip be used with the Over-voltage Adapter model 44300?**

Yes, a power strip can be used with the Over-voltage Adapter, model 44300. This will provide over-voltage protection to the entire power strip. Please use caution when using a power strip to ensure total power consumption does not exceed the rated 15A.

- **How do I tell if my generator has a floating neutral?**

Please consult your generator owner’s manual to determine if the generator was designed with a floating neutral. If your hardwired Surge Guard shows an open ground condition when you are connected to the generator, most likely the generator is designed with a floating neutral. Floating neutral generator configurations are designed for the portable power needs of equipment, typically construction tools. The reason behind the design is to prevent shock if a tool or piece of equipment suffered an internal short circuit.

For Information, Specs, & Troubleshooting Assistance. Please contact us at:
rvpower.southwire.com

CUSTOMER SERVICE

KATHY NEAL

800-780-4324 x 20312

kathy.neal@southwire.com

TECHNICAL SUPPORT

STEVE GUARCELLO

800-780-4324 x 20311 • 727-812-0578

stephen.guarcello@southwire.com

LIMITED LIFETIME & CONNECTED EQUIPMENT WARRANTIES

LIMITED LIFETIME & CONNECTED EQUIPMENT WARRANTIES

Select Surge Guard* products are covered under the Limited Lifetime and Connected Equipment Warranty. This warranty provides coverage for select Surge Guard devices when properly installed according to Southwire's installation procedures, where defects in assembly, materials, or workmanship, caused it to operate outside of design specifications. Please keep in mind that each Surge Guard model includes different features and protection capabilities, thus each claim question should be handled directly between the customer and Southwire Company, LLC. Any misuse, abuse, tampering or modifications made to the products will void the warranty and opportunity to file a claim under the connected equipment policy. The Limited Lifetime Warranty does not cover the purchase of used, salvaged, or refurbished products.

PRODUCTS COVERED UNDER LIMITED LIFETIME WARRANTY

44260/44270 - Surge Protectors with Diagnostics

44280/44290 - Surge Protectors with Enhanced Diagnostics

44380/44390 - UL/CUL Surge Protectors

34930/34931/34950/34951 - Full Protection Portable

35530/35550 - Full Protection Hardwire

44300 - Over-voltage Adapter



44270 44290 34930 34951 44380 35550

WHAT IS CONNECTED EQUIPMENT COVERAGE?

The connected equipment portion of the Southwire Surge Guard warranty will cover the repair/replacement of property that was damaged as a result of a warrantable failure of a Surge Guard product. Since Surge Guard products provide different levels of protection, what can qualify under this coverage will be dependent upon the Surge Guard product being used. Depending on the individual claim, Southwire may request access to damaged equipment and site where damage occurred. Depending upon the claim, Southwire reserves the right to be subrogated under any existing insurance policies of the RV owner.

WARRANTY CLAIM PROCESS

Contact Southwire technical support directly at 1-800-780-4324 to start the return and evaluation process. Please do not return Surge Guard product in question to dealer or retailer. Pending review and evaluation of the returned Surge Guard product, at its discretion, Southwire will provide a new replacement

Surge Guard product of the same or a comparable model. Once RMA an number is issued, please ship Surge Guard device to:

Return Materials Department
Southwire Company, LLC
11211 69th St. North
Largo, FL 33773

Claim processing requires proof of purchase with copy of original receipt with retail purchase date of November 27, 2017 or after to qualify under Southwire's Limited Lifetime and Connect Equipment Warranty.

WHERE TO FIND MORE INFORMATION?

To read the complete warranty, please see pages 25-26 in this training manual or visit rvpower.southwire.com.

LIMITED LIFETIME & CONNECTED EQUIPMENT WARRANTIES

LIMITED PRODUCT WARRANTY

Southwire Company, LLC warrants that this product, when properly installed according to Southwire's installation procedures, shall be free of defects in the materials and workmanship under normal use. The warranty extends only to the original purchaser and is non transferable, unless it was factory installed onto the RV and is then transferable with the RV Coach. During the warranty period, Southwire™ will, at no charge, repair or replace the Surge Guard® product within a reasonable time after the unit is returned to us. This warranty does not extend to any Southwire product that has been damaged or rendered defective (a) as a result of an accident, misuse, or abuse; (b) by the use of parts not manufactured or sold by Southwire; or (c) by modification of product. Labor charges for removal or replacement of the Surge Guard product are the responsibility of the customer. This Limited Warranty covers only products purchased from an authorized dealer, retailer or seller and does not cover used, salvaged or refurbished products.

LIMITED LIFETIME WARRANTY INFORMATION

Any properly installed device that proves defective in normal use will be repaired or replaced at Southwire's option provided the procedure as stated below is followed:

1. Contact Southwire Customer Support at 1-800-780-4324 to obtain a Return Materials Number.
2. Properly package returned unit.
3. Display Return Materials Number on outside of box.
4. Include Proof of Purchase, including date of purchase.
5. Supply full written description of the problem.
6. Specify your name, address, and daytime phone number.
7. Ship unit postage prepaid directly to:

Return Materials Department
Southwire Company, LLC
11211 69th St. North
Largo, FL 33773

NULLIFICATION WARRANTY

The occurrence of any of the following nullifies and voids this warranty:

1. Any non-authorized modification, repair, or physical damage to the Surge Guard product, accidental or otherwise, not caused by a defect in material or workmanship.
2. If Southwire determines that the Surge Guard product has been improperly installed (see installation instructions) altered in any way, or tampered with.

The Warranty does not protect against acts of God, such as direct lightning strikes, flood, earthquake and war. It also does not protect against vandalism, theft, normal use wear and tear, erosion, depletion, obsolescence, abuse, or damage due to low voltage disturbances for products without under voltage protection (i.e. brownouts, sags, or power outages), non authorized program or system equipment modification or alteration.

CONNECTED EQUIPMENT WARRANTY INFORMATION

Notwithstanding anything contained in this warranty, Southwire's liability is limited to losses, which are otherwise covered by this warranty, that are not covered by

purchaser's homeowners insurance or renters insurance. Purchaser agrees to first seek coverage by any such policy, and shall not seek duplicate coverage from Southwire.

Purchaser seeking coverage under this warranty agrees to provide Southwire with insurance information.

SURGE PROTECTION FEATURE

Surge Guard surge protectors are designed to sacrifice themselves in order to save equipment connected to it. If your surge protector is not allowing current to pass and/or the protection working LED indicator is off, then your surge protector has performed its duty, protecting your equipment, and the Limited Lifetime Warranty is void. You will need to purchase a new unit to replace the expired unit.

CONNECTED EQUIPMENT WARRANTY

Southwire will repair or replace, at its option, any equipment which is damaged by transient voltage surge or spike (an "Occurrence"), while properly connected (see installation instructions) through a Surge Guard surge protector to a properly wired AC power line with protective ground and any telephone/coax lines are properly connected. The Surge Guard unit itself is expected to be damaged, thus performing its duty, and you must purchase a new unit to replace the damaged unit. Therefore, the obligation of Southwire to pay or reimburse you for the cost of repair or replace electronic equipment is limited to connected electronic equipment only. No surge protector will protect against a direct lightning strike thus voiding all warranties.

Once Southwire determines, in its sole discretion that you are entitled to compensation, Southwire will, at its option, pay you the present fair market value of the damaged equipment; or pay for the cost of the repair, up to the maximum amount set forth for your Surge Guard model; or send you equivalent replacement equipment.

The fair market value of the equipment shall be the current value of the equipment specified in the most recent edition of the Orion Blue Book by Orion Research Corporation, Roger Rohrs Publisher or a valuation as determined by Southwire at Southwire's discretion.

Southwire reserves the right to review the damaged Surge Guard surge protector, the damaged equipment, and the site where the damage occurred. Southwire shall not repair or replace any equipment that has been discarded before Southwire has had the opportunity to examine it. All costs of shipping the surge protector and the damaged equipment to Southwire shall be borne solely by the purchaser. (Southwire will bear the cost of shipping equipment from Southwire to purchaser). Any repair or modification of the connected equipment or surge protector by a facility or entity not authorized by Southwire voids this warranty. If Southwire determines, in its sole discretion, that it is impractical to ship the damaged equipment, Southwire may designate, in its sole discretion, an equipment repair facility to inspect and estimate the cost to repair such equipment. The cost, if any, of shipping the equipment to and from such repair facility and of such estimate shall be borne solely by the purchaser. Damaged equipment must remain available for inspection until the claim is finalized. Whenever claims are settled, Southwire reserves the right to be subrogated under any existing insurance policies the claimant may have.

LIMITED LIFETIME & CONNECTED EQUIPMENT WARRANTIES

LIMITED LIFETIME & CONNECTED EQUIPMENT WARRANTIES

In lifetime connected equipment warranties, “lifetime” is defined as the time until an event occurs (transient voltage surge or spike) that causes damage to connected equipment or the date that the component providing the surge protection exceeds its capacity and ceases providing protection for surges and spikes. The surge protector will then have performed its duty, and a new surge protector must be purchased.

Standard surge protectors are designed to eliminate disrupting effects of momentary (less than 1 ns) voltage spikes or impulses from lightning or other power transients. If it can be shown that a voltage spike lasting longer than 1 ns has occurred, the Occurrence will be deemed outside the rated capabilities of the surge protector and the warranty is void.

Standard surge protectors are not designed to protect against sustained low voltage situations. Sustained low voltage situations can cause damage to some connected equipment. If you are in an area prone to sustained low voltage situations, you should purchase an Uninterrupted Power Supply (UPS) with surge protection.

Satellite dishes and receivers are not covered by this warranty.

NULLIFICATION OF CONNECTED EQUIPMENT WARRANTY

The occurrence of any of the following nullifies and voids this warranty:

1. If the surge protector or connected equipment in use during the occurrence is not provided to Southwire for inspection upon Southwire’s request.
2. If Southwire determines that the Surge Guard surge protector has been improperly installed (see installation instructions) altered in any way or tampered with.
3. If Southwire determines that the damage did not result from the Occurrence or that no Occurrence in fact took place.
4. If the repair or replacement of the damaged equipment is covered under the manufacturer’s warranty, or purchaser’s homeowner’s insurance or renter’s insurance.
5. If Southwire determines that the connected equipment was not used under normal operating conditions or in accordance with any labels or instructions.
6. If the Surge Guard surge protector was not plugged directly into the power source and/or was “daisy-chained” together in serial fashion with other power strips, UPS, grounding adaptors, other surge protectors, or extension cords.
7. If Southwire determines that the damage to connected equipment was caused by sustained low voltage.
8. Only one claim per household.

If the purchaser collects damages on connected equipment, a new Surge Guard surge protector must be purchased for subsequent protection.

The Southwire Connected Equipment Warranty only protects against damage

to properly connected equipment where Southwire has determined, in its sole discretion, that the Surge Protector did not function properly because it had defects in assembly, materials, or workmanship, causing it to operate outside design specifications, and the surge protector shows clear signs of damage, and the damage resulted from the Occurrence. The Connected Equipment Warranty does not protect against acts of God, such as direct lightning strikes, flood, or earthquake. It also does not protect against war, vandalism, theft, normal use wear and tear, erosion, depletion, obsolescence, abuse, damage due to low voltage disturbances for products without under voltage protection (i.e. brownouts, sags, or power outages), non authorized program or system equipment modification or alteration.

SOLE WARRANTIES

The warranties contained herein are the sole warranties of Southwire™, there are no other warranties, expressed or, except as required by law in the State of Florida, implied, including implied warranty or condition or quality, merchantability or fitness for a particular purpose, and such implied warranties, if any, are limited in duration to the term of this warranty. Southwire expressly disclaims any liability under this warranty for any sums that exceed the retail value of the Surge Guard unit.

No agent or representative of Southwire, retailer, distributor or dealer has any express or implied authority to make any representation, promise, guarantee or warranty not stated in the Limited Product Warranty and Connected Equipment Warranties contained herein.

Except to the extent expressly set forth in the Connected Equipment Warranty contained herein, in no event shall Southwire be liable for indirect, incidental, special consequential or multiple damages arising out of the use of the Surge Guard product, regardless of the legal theory on which such claim is based; even if advised of the possibility of such damage. The excluded damages include, but are not limited to, loss of profits, loss of savings or revenue, loss of life, injury, loss of use of the product or any associated equipment, facilities or services, downtime, the claims of third parties, including customers, and damage to property. Some states do not allow exclusion or limitations of incidental or consequential damages. This warranty is valid in the U.S. and Canada only.

The warranties contained herein are in lieu of all other warranties, obligations or liabilities of Southwire whether express or implied.

Any questions regarding this warranty, please contact Southwire at 1-800-780-4324, or by email at productinfo@southwire.com

**FOR TECHNICAL ASSISTANCE,
PLEASE CALL 1-800-780-4324 X 20358**

Manufactured by Southwire Company, LLC, 11211 69th St. North, Largo, Florida 33773
Made in Honduras

©2023 Southwire Company, LLC. All Rights Reserved.
®, ™, and * Trademark of Southwire Company, LLC.



Southwire™

SURGE*GUARD

TRAINING MANUAL

GET SOCIAL WITH US:



/SOUTHWIRETOOLS



@SOUTHWIRETOOLS



@SOUTHWIRETOOLS



SOUTHWIRETOOLS

SOUTHWIRE.COM | 1-855-SWTOOLS

All Trademarks or Registered Trademarks (TM/®) are owned or licensed by Southwire Company.
Any other ™/®- Trademark or Registered Trademark of Southwire Company.