

SIDES	BOTTOM
Material: Steel-0.024"-G60 Galvanized	

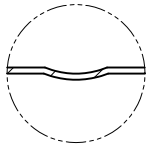

VIEW C 4:1



VIEW D

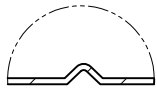

VIEW G-G 4:1

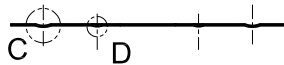
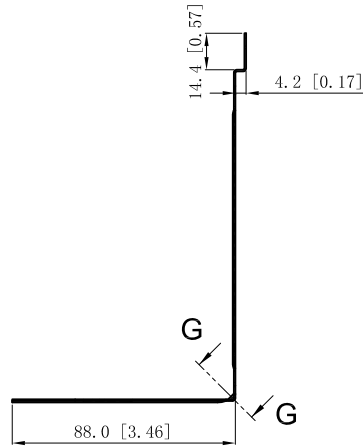

VIEW B-B

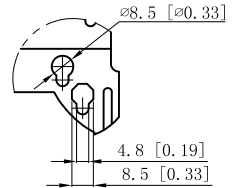
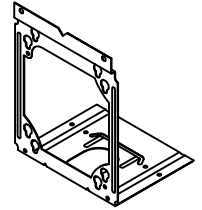
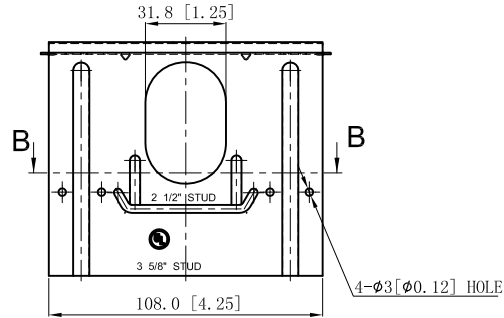
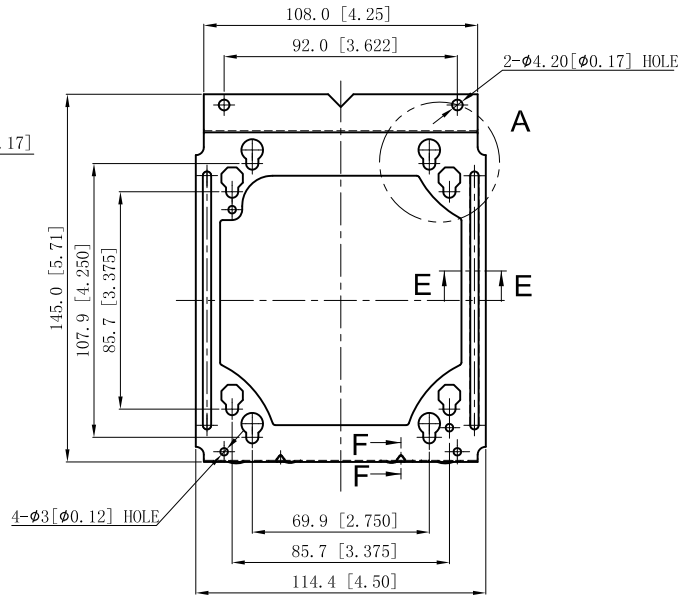

VIEW A



VIEW E-E 4:1



VIEW F-F 4:1

This data sheet is for reference only .GARVIN INDUSTRIES reserves the right to make changes to the design without prior notice.

DESCRIPTION
TRADE REFERENCE TERMS

STANDARD PACKING
50 PCS

<b>GARVIN INDUSTRIES</b>	
TITLE UNIVERSAL BOX BRACKET	
SIZE A4	DWG NO. BB4-25
DATA SHEET	
REV A	