



**Southwire™**

TOOLS & EQUIPMENT

Operating Instructions

# Cable Stripper XTS-01

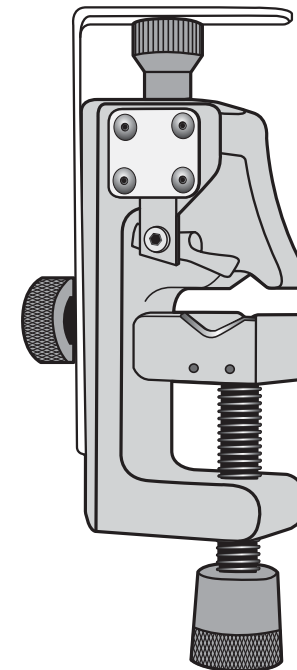

***southwiretools.com***



**1-855-SW-TOOLS**  
Toll Free Technical Help

Contents Made in USA

Product distributed by Southwire Company, LLC  
One Southwire Drive, Carrollton, GA 30119

©2016 Southwire Company, LLC. All rights reserved.



*We've got it*  
**MADE IN AMERICA™**



**Read and understand all of the instructions and safety information  
in this manual before operating or servicing this tool.**





**BEFORE OPERATING THIS TOOL, READ AND UNDERSTAND ALL OF THE INSTRUCTIONS AND SAFETY INFORMATION IN THIS MANUAL**









## TABLE OF CONTENTS

Important Safety Information.....	2
Description of Operation.....	3
Identification.....	3
Operating Instructions.....	3-5
Maintenance.....	5
Specifications.....	5
Replacement.....	5
Warranty.....	6

## SAFETY FIRST

Safety is essential in the use and maintenance of Southwire Tools Assembled Products. This instruction manual and any markings on the tool provide information for avoiding hazards and unsafe practices related to the use of this tool. Observe all of the safety information provided.

 <p><b>SAFETY ALERT SYMBOLS</b></p> <p>These symbols are used to call attention to related hazards or unsafe practices related that could result in injury or property damage. The three safety words defined below indicate the severity of the hazard. The message after the signal word provides information for preventing or avoiding the hazard.</p> <p><b>⚠ DANGER</b></p> <p>Immediate hazards which, if not avoided, WILL result in severe injury or death.</p> <p><b>⚠ WARNING</b></p> <p>Hazards which, if not avoided, COULD result in severe injury or death.</p> <p><b>⚠ CAUTION</b></p> <p>Hazards or unsafe practices which, if not avoided, MAY result in injury or property damage.</p>	 <b>WARNING</b>   <p>Read and understand all of the instructions and safety information in this manual before operating or servicing this tool.</p> <p>Failure to observe this warning could result in severe injury or death.</p>
 <b>WARNING</b>  <p>Electrical Shock Hazards</p> <ul style="list-style-type: none"> <li>• This is not an insulated tool, contact with live circuits could result in severe injury or death.</li> </ul>	<p><b>⚠ WARNING</b></p> <p>Personal safety hazards</p>  <ul style="list-style-type: none"> <li>• Only qualified persons should use a <b>Southwire Cable Stripper</b></li> <li>• Wear eye protection and a hard hat when using this tool</li> <li>• Do not use tool while tired or under the influence of drugs, alcohol, or medication</li> <li>• Keep body parts and loose clothing away from moving parts</li> <li>• Always follow proper safety procedures for operating equipment of this nature</li> <li>• Keep hands clear of precision cutting blade when rotating stripper</li> </ul>
<p><b>⚠ CAUTION</b></p> <ul style="list-style-type: none"> <li>• Do not add extensions (cheaters) to the handles. Using excessive force may result in injury or damage to the tool. If excessive force is required to strip cable, verify blade depth and adjust to type and thickness of material being removed.</li> <li>• Make sure to wear proper eye protection and clear the area around the remnant opening.</li> </ul>	

**FAILURE TO OBSERVE THESE WARNINGS CAN RESULT IN SEVERE INJURY OR DEATH**

## DESCRIPTION OF OPERATION

The **XT Cable Stripper** is made for end and mid-span termination of 600 volt 1/0 to 1000kcmil or outside diameter sizes from (.33"-1.284"). Works on THHN, XHHW, RHH, RHW, and USE jackets.

### IDENTIFICATION

1. Precision Blade Adjustable Thumb Screw
2. Solid Unibody Aluminum Frame
3. Precision Cutting Blade
4. Bottom Adjustable V Shape Cable Clamp
5. Cable Sizing Thumb Screw
6. Depth Adjuster Stop
7. Depth Adjuster Lock

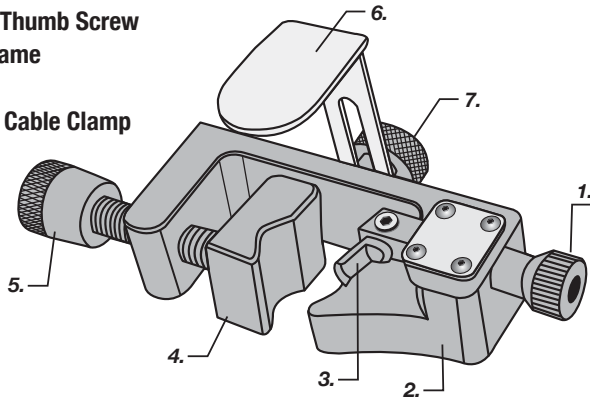

### SETUP AND OPERATION

1. Turn blade adjustment thumb screw counter-clockwise, to fully retract Precision Cutting Blade.
2. Turn cable sizing thumb screw counter-clockwise to open V shape cable clamp.

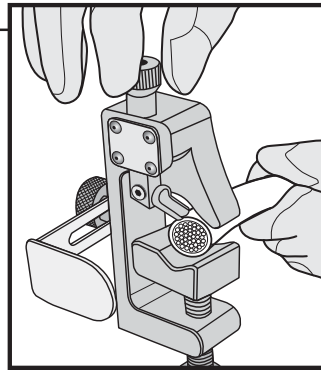

3. Insert cable.

#### 4. Terminations

- 4A. **For End-Termination:** Place wire into V shape clamp with end of wire below precision cutting blade. Disengage the depth adjuster lock by turning it counter-clockwise.

Then rotate the depth adjuster in place and set depth adjuster relative to precision cutting blade.

Once desired depth is attained, secure the depth adjuster lock by turning it clockwise.

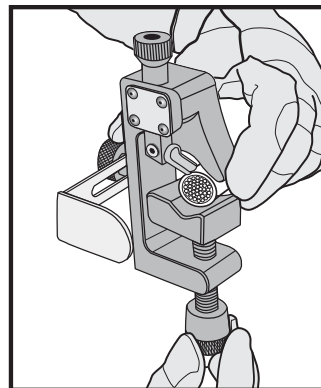

## SETUP AND OPERATION cont.

- 4B. **For Mid-Span:** Align precision cutting blade to start of desired cut.

**Note:** cutting blade will travel towards the solid unibody aluminum frame.

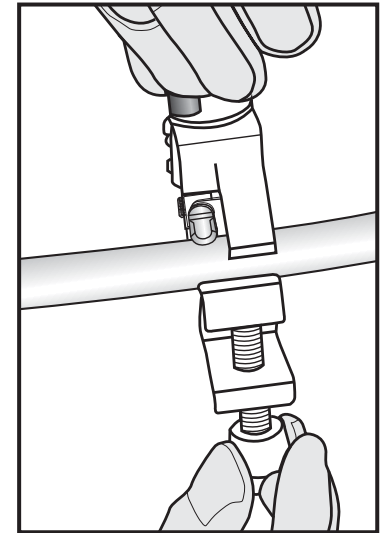

5. Engage V shape cable clamp by turning cable sizing thumb screw clockwise until cable is secured.

**NOTE:** Do not overtighten sizing thumb screw as this may cause binding during operation.

6. Set the precision blade adjustable thumb screw until blade touches the outer jacket of the cable.
7. Rotate complete tool clockwise to start stripping cable.

**NOTE:** small adjustments may be required to achieve required depth of cut.

Adjustments can be made by turning the precision blade adjustable thumb screw clockwise.

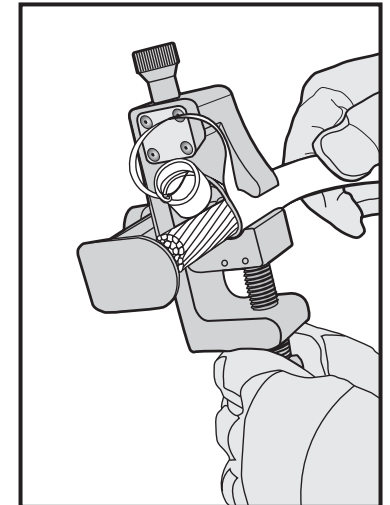

## SETUP AND OPERATION cont.

8A. For End-Termination this can be accomplished with the depth adjuster stop.

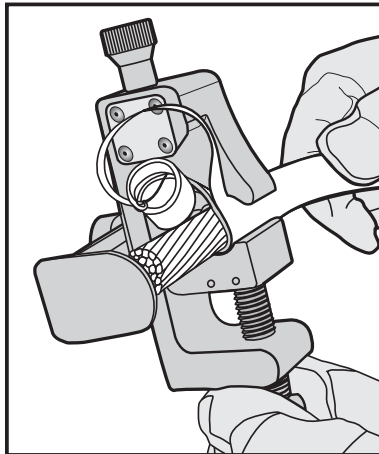

8B. For Mid-Span place a gloved hand against unibody frame while continuing to turn stripper clockwise.

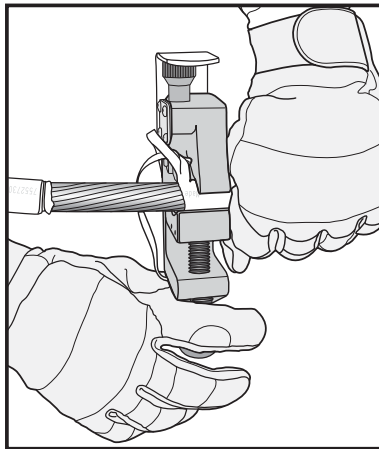

9. Release V shape cable clamp by turning counter clockwise to remove stripper.

## ADDITIONAL HELP

### MAINTENANCE

1. Keep tool clean and dry.
2. Oil moving parts occasionally.
3. To help reduce potential friction and make stripping easier, apply a small amount of grease to the V shaped clamp.
4. Do not alter the blade angles.

### SPECIFICATIONS

- Model# XTS-01
- Length: 2.25"
- Height: 8.5"
- Capacity: 1/0-1000 kcmil
- Stock # 64984901
- Width: 2"
- Weight: 1.3lbs. (.33" - 1.284" Diameter)

### REPLACEMENT BLADE

XTS-01RB	59368901	XTS-01 REPLACEMENT BLADE KIT
----------	----------	------------------------------

## WARRANTY ON SOUTHWIRE CONTRACTOR EQUIPMENT

### Five-Year Limited Warranty on Contractor Equipment

Under Southwire's Contractor Equipment 5-Year Limited Warranty, Southwire Company, LLC warrants that all Southwire Contractor Equipment will be free from manufacturer defects for a period of five (5) years from the date of the original end user's purchase. The following products are excluded from this 5-Year Limited Warranty and are subject to separate warranty terms: rope, blades, dies, draw studs, grips, Southwire Contractor Equipment electronic components, and Material Boxes. Under this 5-Year Limited Warranty, the following are also excluded and Southwire Company, LLC will have no liability for any of the following: normal wear and tear resulting from product use and damage arising out of misuse, abuse, modification, and improper product maintenance. This warranty also does not cover Southwire Contractor Equipment products that have been modified by any party other than Southwire Company, LLC or its authorized third party designee. This 5-Year Limited Warranty is not transferrable to or enforceable by any person other than the product's original end user.

### One-Year Limited Warranty on Rope, Blades, Dies, Draw Studs, Grips, and Southwire Contractor Equipment Electronic Components

Under this 1-Year Limited Warranty, Southwire Company, LLC warrants that all Southwire Ropes, Blades, Dies, Draw Studs, Grips, and Southwire Contractor Equipment Electronic Components will be free from manufacturer defects for a period of one-year from the date of the original end user's purchase. Under this 1-Year Limited Warranty for the aforementioned Southwire Contractor Equipment items, the following are excluded and Southwire Company, LLC will have no liability for any of the following: normal wear and tear resulting from product use and damage arising out of misuse, abuse, modification, and improper product maintenance. This warranty also does not cover Southwire Contractor Equipment that has been modified by any party other than Southwire Company, LLC or its authorized third party designee. This 1-Year Limited Warranty is not transferrable to or enforceable by any person other than the product's original end user.

### Exclusion of Incidental, Consequential, Indirect, Special and Punitive Damages

SOUTHWIRE MAKES NO WARRANTY THAT SOUTHWIRE CONTRACTOR EQUIPMENT PRODUCTS WILL BE MERCHANTABLE OR FIT FOR ANY PARTICULAR PURPOSE. SOUTHWIRE MAKES NO OTHER WARRANTY, EXPRESSED OR IMPLIED, OTHER THAN THE RELEVANT WARRANTY SPECIFICALLY SET FORTH IN THIS WARRANTY SECTION. SOUTHWIRE WILL NOT BE LIABLE FOR ANY INCIDENTAL, CONSEQUENTIAL, INDIRECT, SPECIAL, OR PUNITIVE DAMAGES FOR ANY BREACH OF THIS LIMITED LIFETIME WARRANTY.

*Some states do not allow the exclusion or limitation of incidental or consequential damages, so the above limitation or exclusion may not apply to you.*

## Warranty Claim Information / How Do You Get Service?

For all warranty, customer service, and product return authorizations and inquiries, please contact Southwire's Tools & Assembled Products at:

### Southwire Tools & Assembled Products

840 Old Bremen Rd.  
Carrollton, GA, 30117

**Phone Number: 1.855.SW.Tools**

1. All warranty claims must be approved by Southwire's Tools & Assembled Products Warranty Department prior to return of product. If Southwire determines that a product is defective, Southwire will, at its option, repair or replace defective products or defective product components, free of charge.
2. Upon approval, Southwire will issue a Product Return Authorization Form which will include instructions on how and where to return the product. **The product serial number and the original date of delivery must be set forth on the Product Return Authorization Form.**
3. Southwire will cover standard freight charges (FedEx Ground rate) incurred in connection with products that Southwire ultimately determines to be defective.
4. All defective components and defective products that Southwire replaces under these Warranties will become Southwire's property and will be retained by Southwire.

### Fixing Your Product When it is Out of Warranty

Southwire is happy to provide information about where a purchaser can send a product for repair at consumers' own expense, please contact **1.855.SW.tools** or visit [www.southwiretools.com/tools/home.do](http://www.southwiretools.com/tools/home.do) for more information about servicing for Southwire Products.