

SIDES	BOTTOM
Material:Steel-316 Stainless steel	

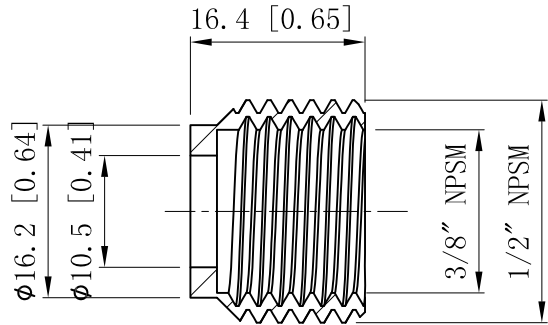

CUTAWAY VIEW A-A

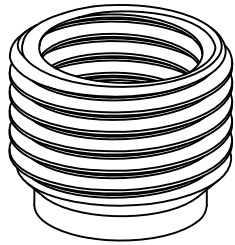
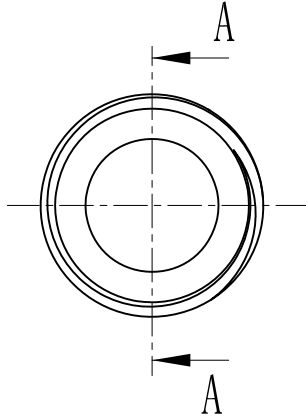

DESCRIPTION
TRADE REFERENCE TERMS

This data sheet is for reference only .GARVIN INDUSTRIES reserves the right to make changes to the design without prior notice.

STANDARD PACKING	<h1 style="text-align: center;">GARVIN INDUSTRIES</h1> <h2 style="text-align: center;">STEEL REDUCING BUSHING</h2>		
100 PCS			
	TITLE		
	SIZE	DWG NO.	REV
	A4	RB-5038-SS	
	DATA SHEET		